



ERGONOMIC SEATING AND MORE

All locally upholstered ranges are
manufactured in Sydney

CATALOGUE 2024-2025

Effective on 01/07/2024





Warranty period for chairs and lounges



Weight rating for individual chairs and lounges*



Fully imported Chairs, lounges, parts and components.



The Performance criteria adopted for certification by Furntech is based on Australian standards, e.g. Level 6 - Severe commercial and heavy industrial.*

**Weight limits are self-rated by Style Ergonomic Australia. AFRDI approved chairs are normally rated to 110kg.*

AFRDI 142 Certification



AFRDI rating for multi shift use and 160kg weight limit.



Furntech is an independent not-for-profit technical organisation providing standards, testing product certification and research for buyers and sellers of furniture.



BIFMA is a third-party certification program that provides manufacturers with valuable feedback for evaluating the environmental, human, and social impacts of their furniture products for manufacturing, facility, and organisation.



All instructions of use are instructed while sitting in the chair.

CONTENTS

R1 - TASK MESH SEATING

Avoca range.....	4
Vesta range	6
Chelsea range	8
Mega range.....	10

R2 - TASK SEATING

Prestige range.....	12
Oriel range	14
Alpha range	16
Virgo range	18
Safari range.....	20
Galaxy range.....	22
Profile range	24
Epic range.....	26
Spiral range.....	28
Comfort range	30
Molta range	32

R3 - MULTI SHIFT SEATING

Rotary range.....	34
Balance range	36
Multi range.....	38
Rover range.....	40
Dueler range.....	42
Control range.....	44

R4 - EXECUTIVE SEATING

Regal range.....	46
Venti range.....	48
Avanti range	50
Kombo range	52
Assist range.....	54

R5 - HOSPITALITY SEATING

Focus range.....	56
Vinn range.....	58
Pod range	60
Maxi range	64
Vera range	66

R6 - BEAM SEATING

Maxi beam	68
Focus beam.....	69
Vinn beam	70
Pod beam	71

R7 - BREAKOUT SEATING

Smoke range	72
Sal range	74
Lush range.....	75
Cuppa range.....	76
Vero range.....	77
Gold range	78
June range.....	80
Time range	81
Opera range.....	82
Leaf range.....	83

R8 - OTTMANS

Play range.....	84
Ola range	85
Clip range	86
Impress range	87
Radius range.....	88

R9 - BAR STOOLS

Gamma.....	89
Lift	89
Vegas.....	89
Flow	89

R10 - SOFT SEATING

Blitz range.....	90
Twist range.....	91
Montage range.....	92
Concept range	93
Shell range	94

R11 - ACOUSTIC SCREENS

Acoustic screens.....	95
-----------------------	----

R12 - INDUSTRIAL STOOLS

State range.....	96
------------------	----

FABRIC OPTIONS

Fabric options	97
----------------------	----

AVOCA RANGE

INSTRUCTION OF USE

To adjust back height hold back with two hands while seated and raise to desired height

To lower the back height raise back all the way to the top and release slowly

RIGHT BACK LEVER
To adjust back angle

RIGHT FRONT LEVER
To adjust seat height

600MM BLACK NYLON 5 STAR BASE WITH CASTORS

Use soft tyred castors for tiles
Use hard tyred castors for carpet

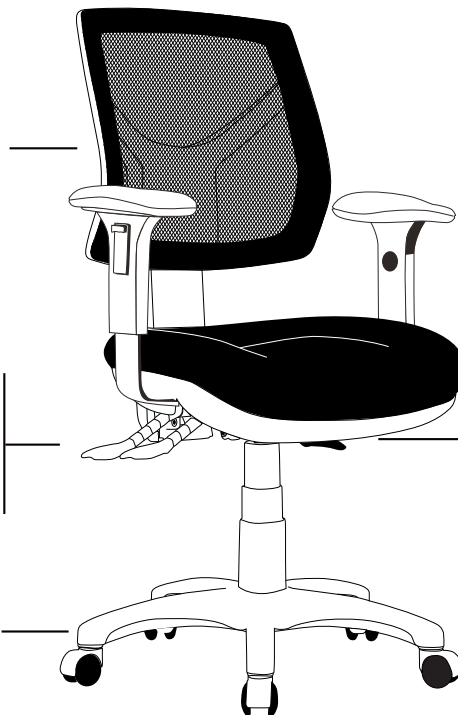

INDOOR USE ONLY

**OPTIONAL
ADJUSTABLE ARMS**

LEFT LEVER
To adjust seat angle

X Do not use as a step ladder

DIMENSIONS: (mm)

LOW BACK LOW BACK TO FLOOR

W: 430 Lowest: 925
H: 450 Highest: 1120

HIGH BACK HIGH BACK TO FLOOR

W: 455 Lowest: 1010
H: 530 Highest: 1210

SEAT

W: 500
D: 460

SEAT TO FLOOR

Lowest: 485
Highest: 625

ARM TO FLOOR

Lowest: 630
Highest: 840

Fabric: Chelsea Sunflower



MAV350H



MAV350



MAV200

Optional:



Drafting kit



Adjustable arm



Colour mesh (Jazz mesh)

Features:

Adjustable seat height
Adjustable back height (ratchet)
Adjustable seat angle (with 3 lever mechanism only)
Adjustable back angle

Optional 2 or 3 lever mechanism
Moulded seat foam
Mesh back
Java seat

600mm black nylon 5 star base
Available in local fabrics
AFRDI tested to level 6
Suitable for indoor use only



VESTA RANGE

INSTRUCTION OF USE

To adjust back height hold back with two hands while seated and raise to desired height

To lower the back height raise back all the way to the top and release slowly

RIGHT BACK LEVER
To adjust back angle

RIGHT FRONT LEVER
To adjust seat height

660MM BLACK NYLON 5 STAR BASE WITH CASTORS

Use soft tyred castors for tiles
Use hard tyred castors for carpet



INDOOR USE ONLY

**OPTIONAL
ADJUSTABLE ARMS**

LEFT LEVER
To adjust seat angle

X Do not use as a step ladder

DIMENSIONS: (mm)

LOW BACK LOW BACK TO FLOOR

W: 430 Lowest: 930
H: 450 Highest: 1130

HIGH BACK HIGH BACK TO FLOOR

W: 455 Lowest: 995
H: 530 Highest: 1205

SEAT

W: 500
D: 480

SEAT TO FLOOR

Lowest: 480
Highest: 600

ARM TO FLOOR

Lowest: 660
Highest: 860

Fabric: Chelsea turpentine



MVE350H



MVE350



MVE200

Optional:



Drafting kit



Adjustable arm



Colour mesh (Jazz mesh)

Features:

Adjustable seat height
Adjustable back height (ratchet)
Adjustable seat angle
(with 3 lever mechanism only)
Adjustable back angle

Optional 2 or 3 lever mechanism
Moulded seat foam
Mesh back
Square seat

660mm black nylon 5 star base
Available in local fabrics
AFRDI tested to level 6
Suitable for indoor use only



CHELSEA RANGE

INDOOR USE ONLY

INSTRUCTION OF USE

To adjust back height hold back with two hands while seated and raise to desired height

To lower the back height raise back all the way to the top and release slowly

RIGHT BACK LEVER
To adjust back angle

RIGHT MIDDLE LEVER
To adjust seat angle

RIGHT FRONT LEVER
To adjust seat height

700MM BLACK NYLON 5 STAR BASE WITH CASTORS

Use soft tyred castors for tiles
Use hard tyred castors for carpet

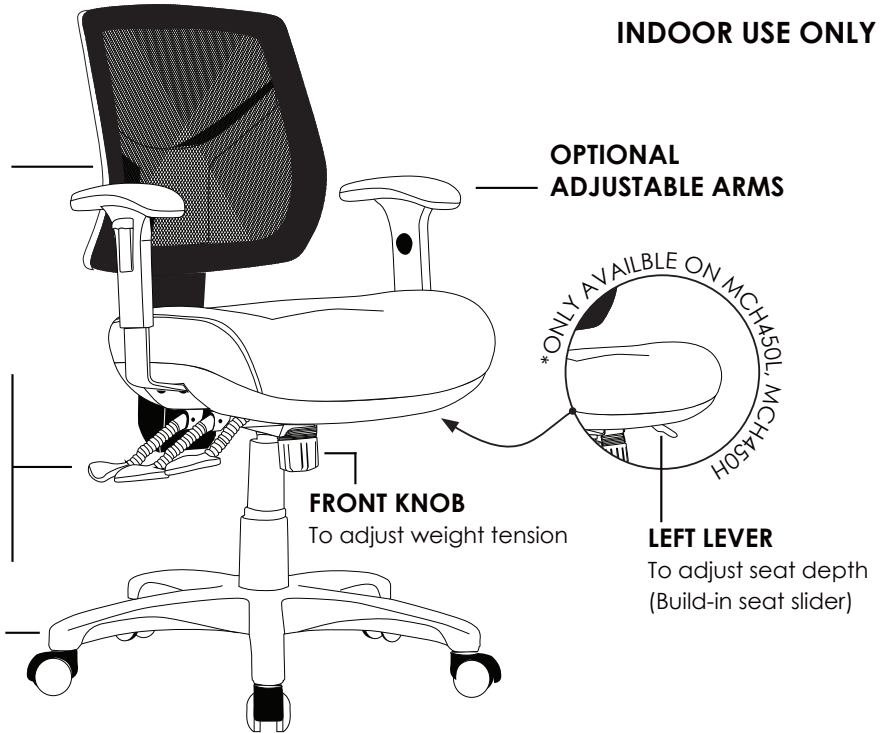

X Do not use as a step ladder

DIMENSIONS: (mm)

LOW BACK LOW BACK TO FLOOR

W: 430 Lowest: 935
H: 450 Highest: 1070

HIGH BACK HIGH BACK TO FLOOR

W: 455 Lowest: 1000
H: 530 Highest: 1150

SEAT

W: 510
D: 480

SEAT TO FLOOR

Lowest: 510
Highest: 590

ARM TO FLOOR

Lowest: 660
Highest: 810

Fabric: Chelsea anemone



MCH450H



MCH600H



MCH600L

Optional:



Drafting kit*
*Not available
in 450 Range



Adjustable
arm



Colour mesh
(Jazz mesh)

Features:

Adjustable seat height
Adjustable back height (ratchet)
Adjustable seat and back angle
Adjustable weight tension

Adjustable seat depth (build-in seat slider)
(with MCH450L, MCH450H only)
Moulded seat foam
Mesh back
Big boy seat

700mm black nylon 5 star base
Available in local fabrics
AFRDI tested to level 6
Suitable for indoor use only



MEGA RANGE

INSTRUCTION OF USE

To adjust back height hold back with two hands while seated and raise to desired height

To lower the back height raise back all the way to the top and release slowly

RIGHT BACK LEVER
To adjust back angle

RIGHT MIDDLE LEVER
To adjust seat angle

RIGHT FRONT LEVER
To adjust seat height

700MM BLACK NYLON 5 STAR BASE WITH CASTORS

Use soft tyred castors for tiles
Use hard tyred castors for carpet



INDOOR USE ONLY

**OPTIONAL
ADJUSTABLE ARMS**

FRONT KNOB
To adjust weight tension

X Do not use as a step ladder

DIMENSIONS: (mm)

BACK

W: 450

H: 530

BACK TO FLOOR

Lowest: 1025

Highest: 1150

SEAT

W: 560

D: 510

SEAT TO FLOOR

Lowest: 520

Highest: 600

ARM TO FLOOR

Lowest: 665

Highest: 830

Fabric: Chelsea mint



MEGA



MEGA-C



back view

Optional:



Colour mesh
(Jazz mesh)

Features:

Adjustable seat height
Adjustable back height (ratchet)
Adjustable seat and back angle
Adjustable weight tension

Moulded seat foam
Mesh back
Mega big boy seat
3 lever heavy duty ergonomic mechanism

700mm black nylon 5 star base
Available in local fabrics
AFRDI tested to level 6
Suitable for indoor use only



PRESTIGE RANGE

INSTRUCTION OF USE

INDOOR USE ONLY

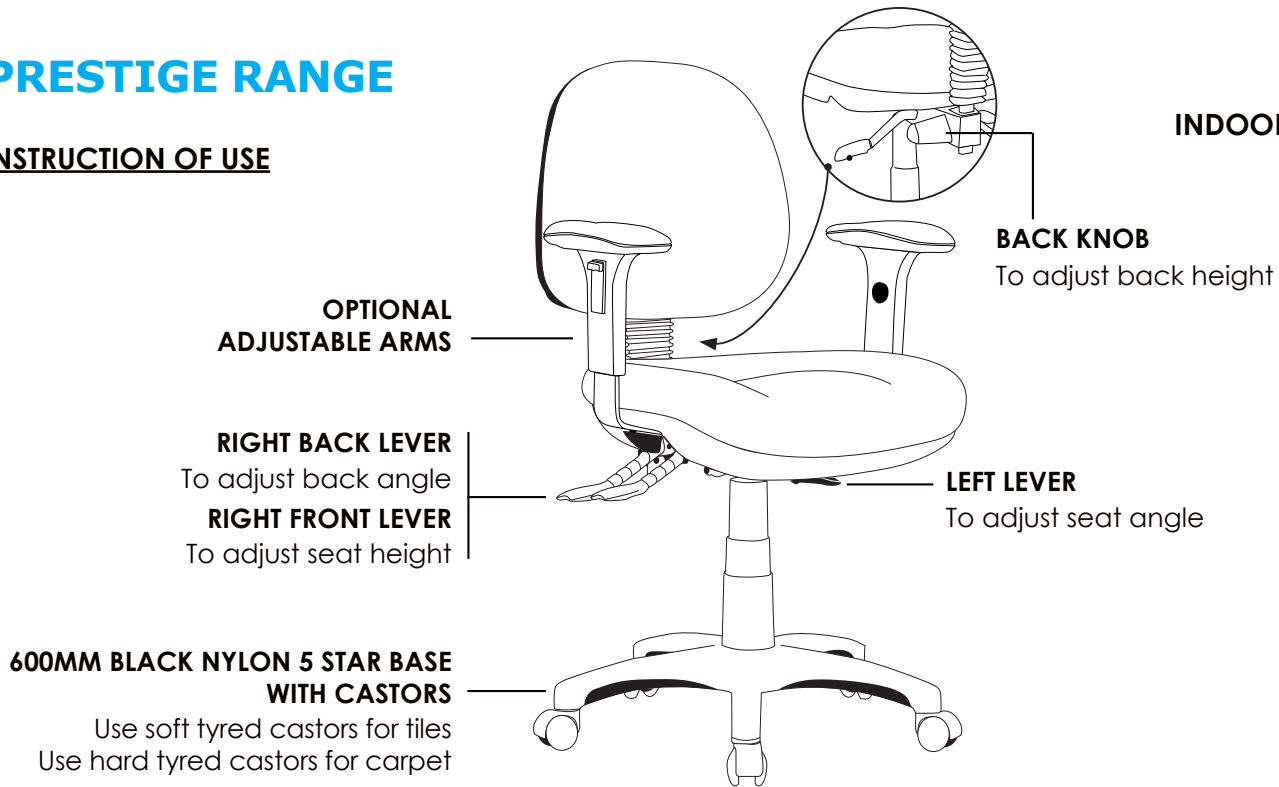

X Do not use as a step ladder

DIMENSIONS: (mm)

LOW BACK LOW BACK TO FLOOR

W: 440 Lowest: 860
H: 400 Highest: 1045

HIGH BACK HIGH BACK TO FLOOR

W: 450 Lowest: 950
H: 510 Highest: 1150

SEAT

W: 500
D: 460

SEAT TO FLOOR

Lowest: 480
Highest: 625

ARM TO FLOOR

Lowest: 630
Highest: 840

Fabric: Chelsea daisy



P350H



P350



P200

Optional:



Drafting kit



Adjustable arm

Features:

Adjustable seat height
Adjustable back height
Adjustable seat angle
(with 3 lever mechanism only)

Adjustable back angle
Optional 2 or 3 lever mechanism
Moulded seat and back foam
Java seat

600mm black nylon 5 star base
Available in local fabrics
AFRDI tested to level 6
Suitable for indoor use only



ORIEL RANGE

INSTRUCTION OF USE

To adjust back height hold back with two hands while seated and raise to desired height

To lower the back height raise back all the way to the top and release slowly

RIGHT BACK LEVER

To adjust back angle

RIGHT FRONT LEVER

To adjust seat height

600MM BLACK NYLON 5 STAR BASE WITH CASTORS

Use soft tyred castors for tiles
Use hard tyred castors for carpet

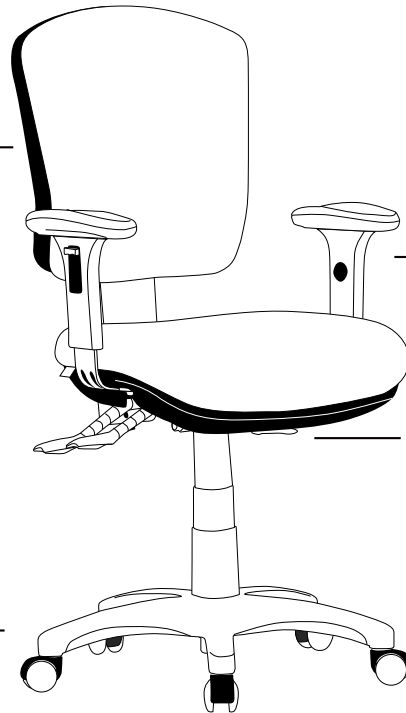

INDOOR USE ONLY

**OPTIONAL
ADJUSTABLE ARMS**

LEFT LEVER

To adjust seat angle

X Do not use as a step ladder

DIMENSIONS: (mm)

LOW BACK LOW BACK TO FLOOR

W: 460 Lowest: 850
H: 440 Highest: 1060

HIGH BACK HIGH BACK TO FLOOR

W: 470 Lowest: 950
H: 540 Highest: 1170

SEAT

W: 500
D: 460

SEAT TO FLOOR

Lowest: 485
Highest: 625

ARM TO FLOOR

Lowest: 630
Highest: 840

Fabric: Chelsea ryegrass



OR350H



OR350



OR200

Optional:



Drafting kit



Adjustable arm

Features:

Adjustable seat height
Adjustable back height (ratchet)
Adjustable seat angle
(with 3 lever mechanism only)

Adjustable back angle
Optional 2 or 3 lever mechanism
Moulded seat and back foam
Java seat

600mm black nylon 5 star base
Available in local fabrics
AFRDI tested to level 6
Suitable for indoor use only



ALPHA RANGE

INSTRUCTION OF USE

To adjust back height hold back with two hands while seated and raise to desired height

To lower the back height raise back all the way to the top and release slowly

RIGHT BACK LEVER
To adjust back angle

RIGHT FRONT LEVER
To adjust seat height

600MM BLACK NYLON 5 STAR BASE WITH CASTORS

Use soft tyred castors for tiles
Use hard tyred castors for carpet



INDOOR USE ONLY

**OPTIONAL
ADJUSTABLE ARMS**

LEFT LEVER
To adjust seat angle

X Do not use as a step ladder

DIMENSIONS: (mm)

LOW BACK LOW BACK TO FLOOR

W: 440 Lowest: 935
H: 460 Highest: 1120

HIGH BACK HIGH BACK TO FLOOR

W: 450 Lowest: 1020
H: 560 Highest: 1240

SEAT

W: 500
D: 460

SEAT TO FLOOR

Lowest: 485
Highest: 625

ARM TO FLOOR

Lowest: 630
Highest: 840

Fabric: Chelsea laurel



AL350H



AL350



AL200

Optional:



Drafting kit



Adjustable arm

Features:

Adjustable seat height
Adjustable back height (ratchet)
Adjustable seat angle
(with 3 lever mechanism only)

Adjustable back angle
Optional 2 or 3 lever mechanism
Moulded seat and back foam
Java seat

600mm black nylon 5 star base
Available in local fabrics
AFRDI tested to level 6
Suitable for indoor use only



VIRGO RANGE

INSTRUCTION OF USE

To adjust back height hold back with two hands while seated and raise to desired height

To lower the back height raise back all the way to the top and release slowly

RIGHT BACK LEVER
To adjust back angle

RIGHT FRONT LEVER
To adjust seat height

660MM BLACK NYLON 5 STAR BASE WITH CASTORS

Use soft tyred castors for tiles
Use hard tyred castors for carpet

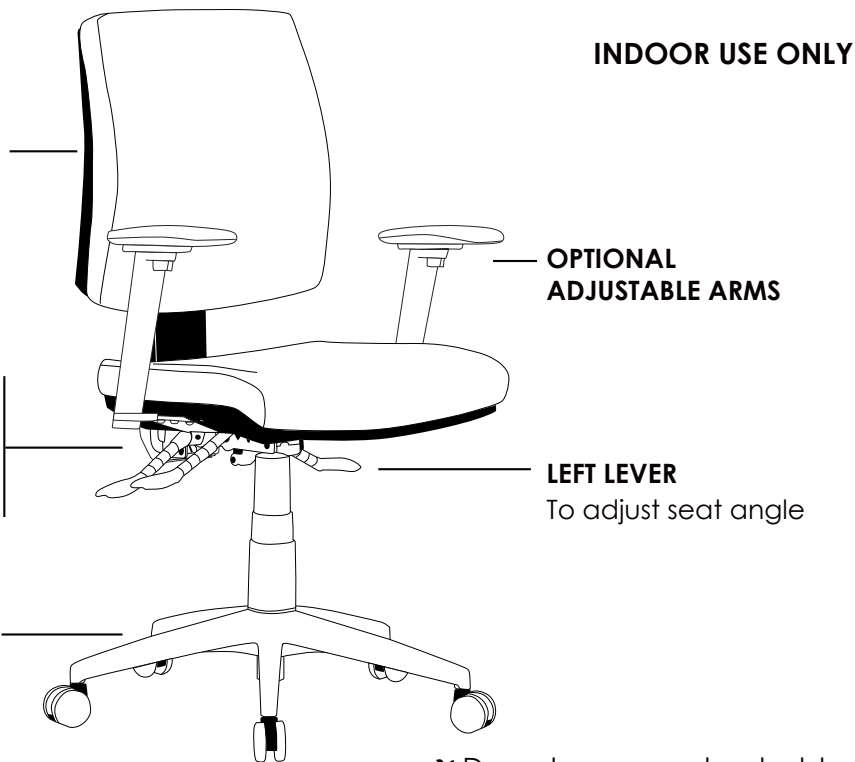

DIMENSIONS: (mm)

LOW BACK LOW BACK TO FLOOR

W: 440 Lowest: 900
H: 460 Highest: 1110

HIGH BACK HIGH BACK TO FLOOR

W: 450 Lowest: 910
H: 560 Highest: 1120

SEAT

W: 500
D: 480

SEAT TO FLOOR

Lowest: 480
Highest: 600

ARM TO FLOOR

Lowest: 660
Highest: 860

Fabric: Chelsea slate



VI350H



VI350



VI200

Optional:



Drafting kit



Adjustable arm

Features:

Adjustable seat height
Adjustable back height (ratchet)
Adjustable seat angle
(with 3 lever mechanism only)

Adjustable back angle
Optional 2 or 3 lever mechanism
Moulded seat and back foam
Square seat

660mm black nylon 5 star base
Available in local fabrics
AFRDI tested to level 6
Suitable for indoor use only



SAFARI RANGE

INSTRUCTION OF USE

To adjust back height hold back with two hands while seated and raise to desired height

To lower the back height raise back all the way to the top and release slowly

RIGHT BACK LEVER
To adjust back angle

RIGHT FRONT LEVER
To adjust seat height

700MM BLACK NYLON 6 STAR BASE WITH CASTORS

Use soft tyred castors for tiles
Use hard tyred castors for carpet

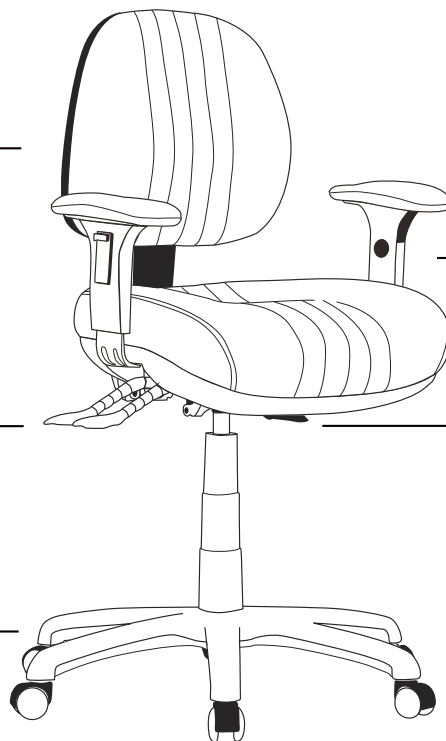

INDOOR USE ONLY

OPTIONAL ADJUSTABLE ARMS

LEFT LEVER
To adjust seat angle

X Do not use as a step ladder

DIMENSIONS: (mm)

LOW BACK LOW BACK TO FLOOR

W: 440 Lowest: 930
H: 400 Highest: 1140

HIGH BACK HIGH BACK TO FLOOR

W: 450 Lowest: 990
H: 510 Highest: 1185

SEAT

W: 510
D: 480

SEAT TO FLOOR

Lowest: 530
Highest: 670

ARM TO FLOOR

Lowest: 670
Highest: 880

Fabric: Chelsea bark



SA350H



SA350



SA200

Optional:



Drafting kit



Adjustable arm

Features:

Adjustable seat height
Adjustable back height (ratchet)
Adjustable seat angle
(with 3 lever mechanism only)

Adjustable back angle
Optional 2 or 3 lever mechanism
Moulded seat and back foam
Firm kidney and lumbar support

Big boy seat
700mm black nylon 6 star base
Available in local fabrics
Suitable for indoor use only



GALAXY RANGE

INDOOR USE ONLY

INSTRUCTION OF USE

To adjust back height hold back with two hands while seated and raise to desired height

To lower the back height raise back all the way to the top and release slowly

RIGHT BACK LEVER

To adjust back angle

RIGHT MIDDLE LEVER

To adjust seat angle

RIGHT FRONT LEVER

To adjust seat height

700MM BLACK NYLON 5 STAR BASE WITH CASTORS

Use soft tyred castors for tiles
Use hard tyred castors for carpet

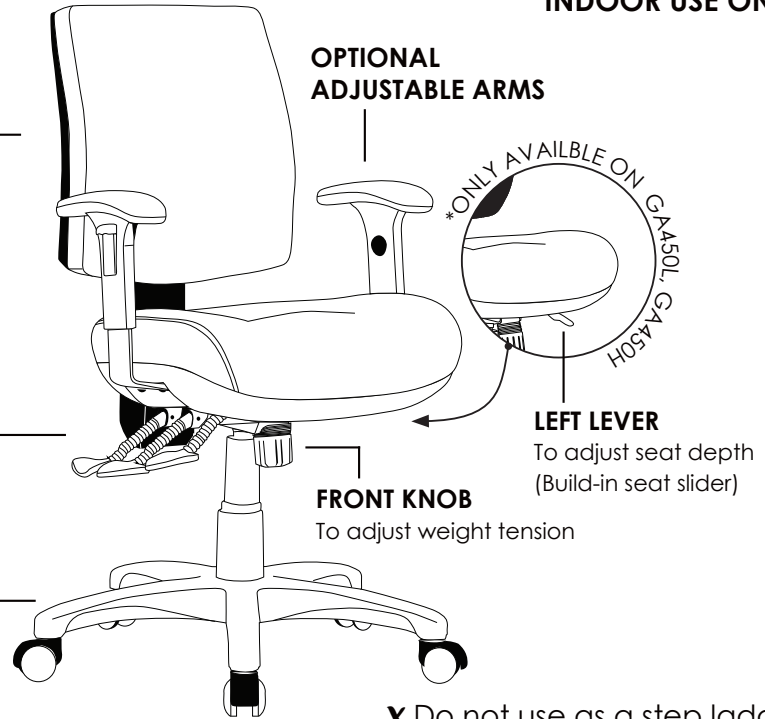

X Do not use as a step ladder

DIMENSIONS: (mm)

LOW BACK LOW BACK TO FLOOR

W: 440 Lowest: 920

H: 460 Highest: 1070

HIGH BACK HIGH BACK TO FLOOR

W: 450 Lowest: 1020

H: 560 Highest: 1155

SEAT

W: 510

D: 480

SEAT TO FLOOR

Lowest: 525

Highest: 605

ARM TO FLOOR

Lowest: 670

Highest: 815

Fabric: Chelsea lobelia



GA450H



GA600H



GA600L

Optional:



Drafting kit
*Not available
in 450 Range



Adjustable
arm

Features:

Adjustable seat height
Adjustable back height (ratchet)
Adjustable seat and back angle
Adjustable weight tension

Adjustable seat depth (build-in seat slider)
(with GA450L, GA450H only)
Moulded seat and back foam
Big boy seat

700mm black nylon 5 star base
Available in local fabrics
AFRDI tested to level 6
Suitable for indoor use only



PROFILE RANGE

INSTRUCTION OF USE

To adjust back height hold back with two hands while seated and raise to desired height

To lower the back height raise back all the way to the top and release slowly

RIGHT BACK LEVER

To adjust back angle

RIGHT MIDDLE LEVER

To adjust seat angle

RIGHT FRONT LEVER

To adjust seat height

700MM BLACK NYLON 5 STAR BASE WITH CASTORS

Use soft tyred castors for tiles
Use hard tyred castors for carpet

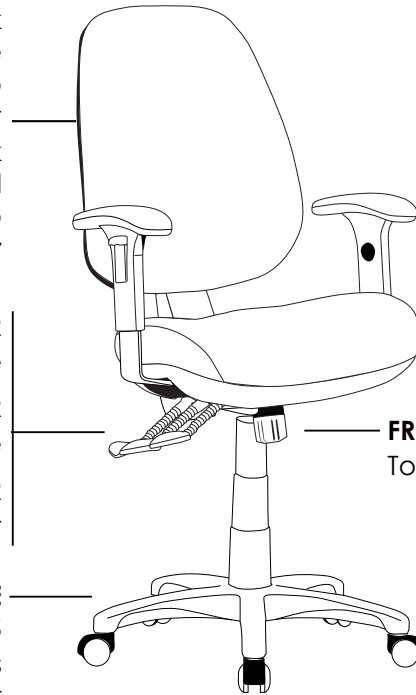

INDOOR USE ONLY

**OPTIONAL
ADJUSTABLE ARMS**

FRONT KNOB
To adjust weight tension

X Do not use as a step ladder

DIMENSIONS: (mm)

BACK

W: 490

H: 580

BACK TO FLOOR

Lowest: 1025

Highest: 1175

SEAT

W: 510

D: 480

SEAT TO FLOOR

Lowest: 525

Highest: 605

ARM TO FLOOR

Lowest: 670

Highest: 815

Fabric: Chelsea crocus



PR600



PR600C



back view

Optional:



Drafting kit

Features:

Adjustable seat height
Adjustable back height (ratchet)
Adjustable seat and back angle
Adjustable weight tension

Moulded seat and back foam
Big boy seat
3 lever heavy duty ergonomic mechanism
700mm black nylon 5 star base



Available in local fabrics
AFRDI tested to level 6
Suitable for indoor use only

EPIC RANGE

INSTRUCTION OF USE

To adjust back height hold back with two hands while seated and raise to desired height

To lower the back height raise back all the way to the top and release slowly

RIGHT BACK LEVER
To adjust back angle

RIGHT MIDDLE LEVER
To adjust seat angle

RIGHT FRONT LEVER
To adjust seat height

700MM BLACK NYLON 5 STAR BASE WITH CASTORS

Use soft tyred castors for tiles
Use hard tyred castors for carpet



INDOOR USE ONLY

**OPTIONAL
ADJUSTABLE ARMS**

FRONT KNOB
To adjust weight tension

X Do not use as a step ladder

DIMENSIONS: (mm)

BACK

W: 490

H: 580

BACK TO FLOOR

Lowest: 1080

Highest: 1240

SEAT

W: 560

D: 510

SEAT TO FLOOR

Lowest: 520

Highest: 600

ARM TO FLOOR

Lowest: 665

Highest: 830

Fabric: Chelsea erylgo



EPIC



EPIC-C



back view

Features:

Adjustable seat height
Adjustable back height (ratchet)
Adjustable seat and back angle
Adjustable weight tension

Moulded seat and back foam
Mega big boy seat
3 lever heavy duty ergonomic mechanism
700mm black nylon 5 star base



Available in local fabrics
AFRDI tested to level 6
Suitable for indoor use only

SPIRAL RANGE

INSTRUCTION OF USE

To adjust back height hold back with two hands while seated and raise to desired height

To lower the back height raise back all the way to the top and release slowly

RIGHT BACK LEVER
To adjust back angle

RIGHT MIDDLE LEVER
To adjust seat angle

RIGHT FRONT LEVER
To adjust seat height

700MM BLACK NYLON 5 STAR BASE WITH CASTORS

Use soft tyred castors for tiles
Use hard tyred castors for carpet



INDOOR USE ONLY

**OPTIONAL
ADJUSTABLE ARMS**

FRONT KNOB
To adjust weight tension

X Do not use as a step ladder

DIMENSIONS: (mm)

BACK

W: 460

H: 560

BACK TO FLOOR

Lowest: 1025

Highest: 1165

SEAT

W: 560

D: 510

SEAT TO FLOOR

Lowest: 520

Highest: 600

ARM TO FLOOR

Lowest: 665

Highest: 830

Fabric: Chelsea olive



SPIRAL



SPIRAL-C



back view

Features:

Adjustable seat height
Adjustable back height (ratchet)
Adjustable seat and back angle
Adjustable weight tension

Moulded seat and back foam
Mega big boy seat
3 lever heavy duty ergonomic mechanism
700mm black nylon 5 star base

Available in local fabrics
AFRDI tested to level 6
Suitable for indoor use only



COMFORT RANGE

INSTRUCTION OF USE

To adjust back height hold back with two hands while seated and raise to desired height

To lower the back height raise back all the way to the top and release slowly

RIGHT BACK LEVER
To adjust back angle

RIGHT MIDDLE LEVER
To adjust seat angle

RIGHT FRONT LEVER
To adjust seat height

700MM BLACK NYLON 6 STAR BASE WITH CASTORS

Use soft tyred castors for tiles
Use hard tyred castors for carpet



INDOOR USE ONLY

**OPTIONAL
ADJUSTABLE ARMS**

FRONT KNOB
To adjust weight tension

X Do not use as a step ladder

DIMENSIONS: (mm)

BACK

W: 470

H: 550

BACK TO FLOOR

Lowest: 1050

Highest: 1190

SEAT

W: 560

D: 510

SEAT TO FLOOR

Lowest: 530

Highest: 600

ARM TO FLOOR

Lowest: 660

Highest: 800



COMFORT



COMFORT-C



back view

Features:

Adjustable seat height
Adjustable back height (ratchet)
Adjustable seat and back angle
Adjustable weight tension

Moulded seat and back foam
Mega big boy seat
3 lever heavy duty ergonomic mechanism
700mm black nylon 6 star base

Available in local fabrics
Suitable for indoor use only



MOLTA RANGE

INSTRUCTION OF USE

To adjust back height hold back with two hands while seated and raise to desired height

To lower the back height raise back all the way to the top and release slowly

RIGHT BACK LEVER

To adjust back angle

RIGHT MIDDLE LEVER

To adjust seat angle

RIGHT FRONT LEVER

To adjust seat height

700MM BLACK NYLON 6 STAR BASE WITH CASTORS

Use soft tyred castors for tiles
Use hard tyred castors for carpet



INDOOR USE ONLY

**OPTIONAL
ADJUSTABLE ARMS**

FRONT KNOB

To adjust weight tension

X Do not use as a step ladder

DIMENSIONS: (mm)

BACK

W: 500

H: 550

BACK TO FLOOR

Lowest: 1050

Highest: 1190

SEAT

W: 560

D: 510

SEAT TO FLOOR

Lowest: 530

Highest: 600

ARM TO FLOOR

Lowest: 660

Highest: 800



MOLTA



MOLTA-C



back view

Features:

Adjustable seat height
Adjustable back height (ratchet)
Adjustable seat and back angle
Adjustable weight tension

Moulded seat and back foam
Mega big boy seat
3 lever heavy duty ergonomic mechanism
700mm black nylon 6 star base

Available in local fabrics
Suitable for indoor use only



ROTARY RANGE

INDOOR USE ONLY

INSTRUCTION OF USE

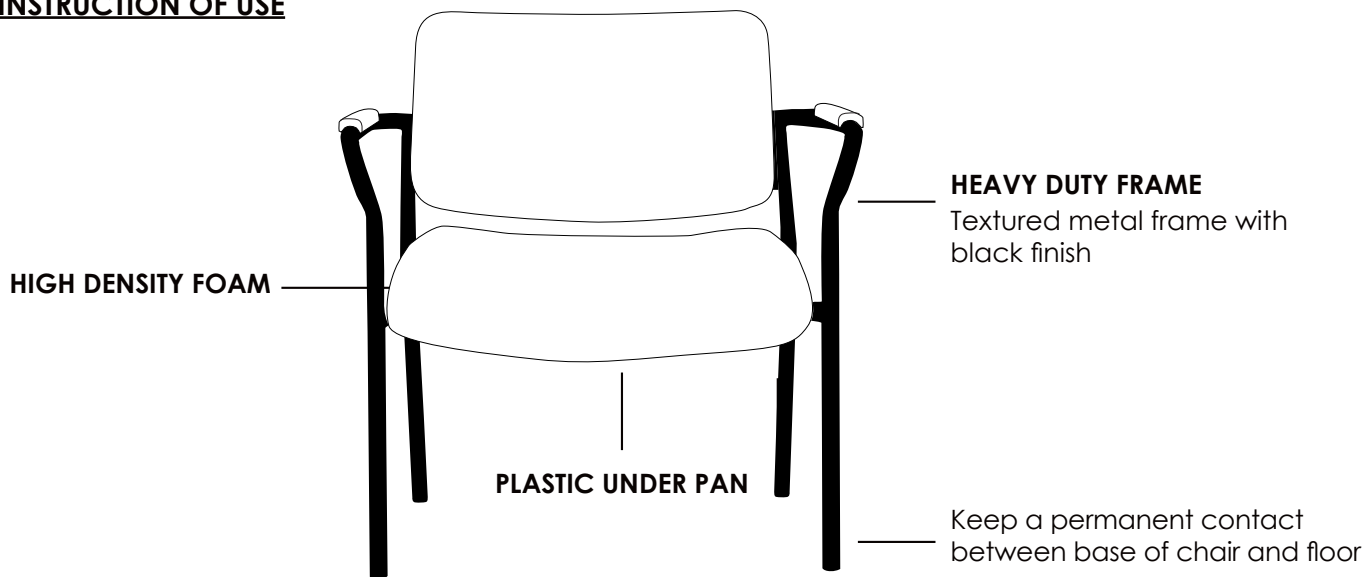

X Do not use as a step ladder

DIMENSIONS: (mm)

600		
BACK	SEAT	OVERALL
W: 600	W: 500	W: 660
H: 330	D: 520	H: 760
		D: 640

700		
BACK	SEAT	OVERALL
W: 700	W: 630	W: 770
H: 330	D: 520	H: 760
		D: 640

SEAT TO FLOOR
460

ARM TO FLOOR
630



ROTARY-600



ROTARY-700



back view

Features:

High density foam
Plastic under pan

Heavy duty black textured metal frame
Available in local fabrics

Suitable for indoor use only



BALANCE RANGE

INSTRUCTION OF USE

INDOOR USE ONLY

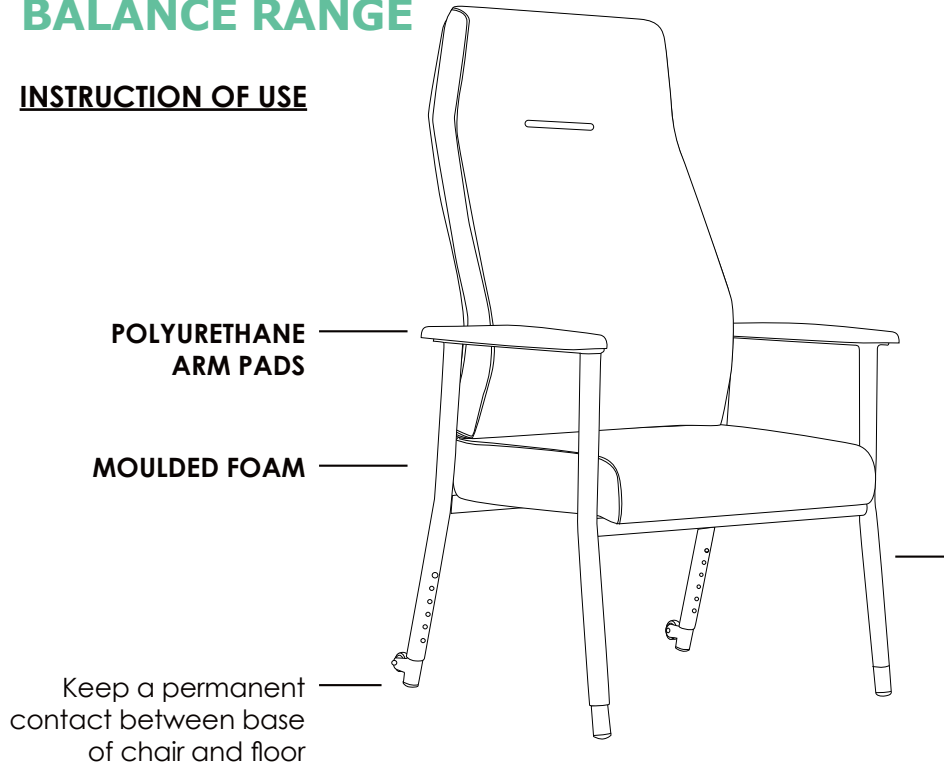

ADJUSTABLE HEIGHT

Please avoid adjusting the chair height whilst you are seated

Carefully tilt the chair onto its back to access the leg height adjustment

While the chair is tilted, press the button to release the tension

With the button engaged, pull the leg extension up or down to your desired height

The wheels located at the back of the chair assist with chair mobility

Do not move the chair while someone is seated, to avoid accidents

X Do not use as a step ladder

DIMENSIONS: (mm)

**H-600
OVERALL**
W: 645
H: 1130
D: 660

**L-600
OVERALL**
W: 645
H: 910
D: 660

**H-700
OVERALL**
W: 745
H: 1130
D: 660

**L-700
OVERALL**
W: 745
H: 910
D: 660

**LOW BACK
TO FLOOR**
Lowest: 910
Highest: 1030

**HIGH BACK
TO FLOOR**
Lowest: 1130
Highest: 1250

SEAT TO FLOOR
Lowest: 445
Highest: 565

ARM TO FLOOR
Lowest: 665
Highest: 785



BAL-H-700



BAL-H-600



BAL-L-700



BAL-L-600

Features:

Bariatric chair
Suitable for age care and hospital use
Adjustable feet

Polyurethane arm pads
Moulded seat and back foam

Available in local fabrics
Suitable for indoor use only



MULTI RANGE

INSTRUCTION OF USE

To adjust back height hold back with two hands while seated and raise to desired height

To lower the back height raise back all the way to the top and release slowly (LOW BACK ONLY)

RIGHT BACK KNOB

To adjust seat depth (seat slider)

RIGHT BACK LEVER

To adjust back angle

RIGHT MIDDLE LEVER

To adjust seat angle

RIGHT FRONT LEVER

To adjust seat height

700MM ALUMINIUM 5 STAR BASE WITH CASTORS

Use soft tyred castors for tiles
Use hard tyred castors for carpet

INDOOR USE ONLY

ADJUSTABLE ARMS

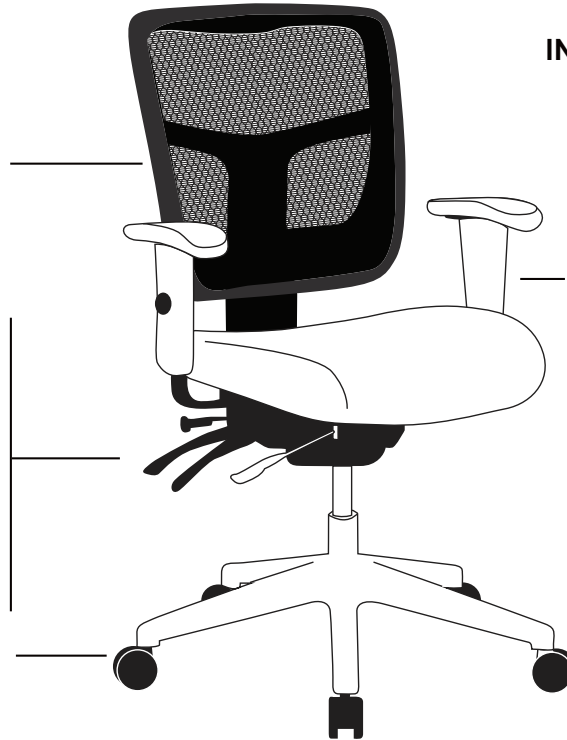

X Do not use as a step ladder

DIMENSIONS: (mm)

LOW BACK	BACK TO FLOOR	MEDIUM BACK	BACK TO FLOOR	HEADREST	HIGH BACK TO FLOOR	SEAT	SEAT TO FLOOR	ARM TO FLOOR
W: 500	Lowest: 910	W: 500	Lowest: 1040	W: 345	Lowest: 1180	W: 500	Lowest: 480	Lowest: 660
H: 500	Highest: 1045	H: 660	Highest: 1130	H: 170	Highest: 1360	D: 470	Highest: 570	Highest: 810

* Please note that the Headrest should not be used to manoeuvre the chair.



MUEX1H



MUEX1M



MUEX1L

Features:

Adjustable seat height
Adjustable back height (ratchet)
(Available in low back only)
Adjustable seat and back angle

Adjustable seat depth (seat slider)
Adjustable arms
Moulded seat foam
Mesh back

4 lever ergonomic mechanism
700mm aluminium 5 star base
Available in local fabrics
Suitable for indoor use only



ROVER RANGE

INSTRUCTION OF USE

To adjust back height hold back with two hands while seated and raise to desired height

To lower the back height raise back all the way to the top and release slowly

RIGHT FOURTH LEVER
To adjust back angle

RIGHT THIRD LEVER
To adjust seat angle

RIGHT SECOND LEVER
To adjust seat height

RIGHT FRONT LEVER
To adjust seat front angle

700MM BLACK NYLON 5 STAR BASE WITH CASTORS

Use soft tyred castors for tiles

Use hard tyred castors for carpet

INDOOR USE ONLY



X Do not use as a step ladder

DIMENSIONS: (mm)

LOW BACK	BACK TO FLOOR	HIGH BACK	BACK TO FLOOR	SEAT	SEAT TO FLOOR	ARM TO FLOOR
W: 510	Lowest: 980	W: 500	Lowest: 1095	W: 510	Lowest: 480	Lowest: 640
H: 540	Highest: 1140	H: 630	Highest: 1260	D: 520	Highest: 570	Highest: 790

Fabric: Jazz black



ROVER-2HA



ROVER-2LA



back view

Features:

Adjustable seat height
Adjustable back height (ratchet)
Adjustable seat and back angle
Adjustable weight tension

Adjustable arms
Moulded seat and back foam
4 lever ergonomic mechanism

700mm black nylon 5 star base
Available in local fabrics
Suitable for indoor use only



DUELER RANGE

INSTRUCTION OF USE

INDOOR USE ONLY

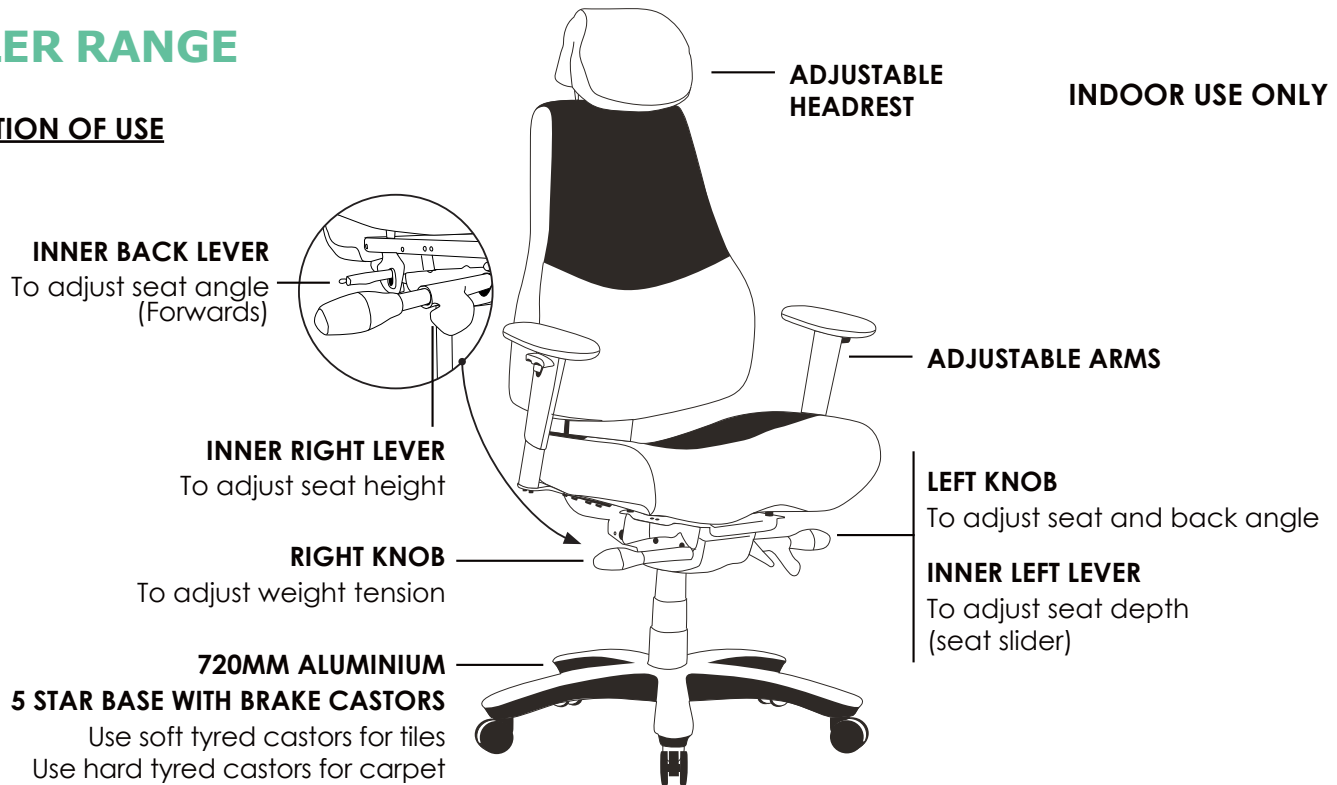

X Do not use as a step ladder

DIMENSIONS: (mm)

BACK WITH HEADREST

W: 475

H: 720

HEADREST TO FLOOR

Lowest: 1230

Highest: 1350

SEAT

W: 515

D: 540

SEAT TO FLOOR

Lowest: 525

Highest: 645

ARM TO FLOOR

Lowest: 700

Highest: 920

Fabric: Lana sapphire



DUELER



side view



back view

** Please note that the Headrest should not be used to manoeuvre the chair.*

Features:

Adjustable seat height

Adjustable seat and back angle

Forward seat tilt adjustment

Adjustable seat depth (seat slider)

Adjustable weight tension

Adjustable arms

Adjustable headrest

Moulded seat and back foam

Saddle seat

Synchron mechanism with 3 locking positions

720mm aluminium 5 star base



AFRDI 142 Certification



Brake castors

Available in local fabrics

AFRDI tested to level 6

AFRDI tested to multi shift use 160kg

Suitable for indoor use only

CONTROL RANGE

INDOOR USE ONLY

INSTRUCTION OF USE

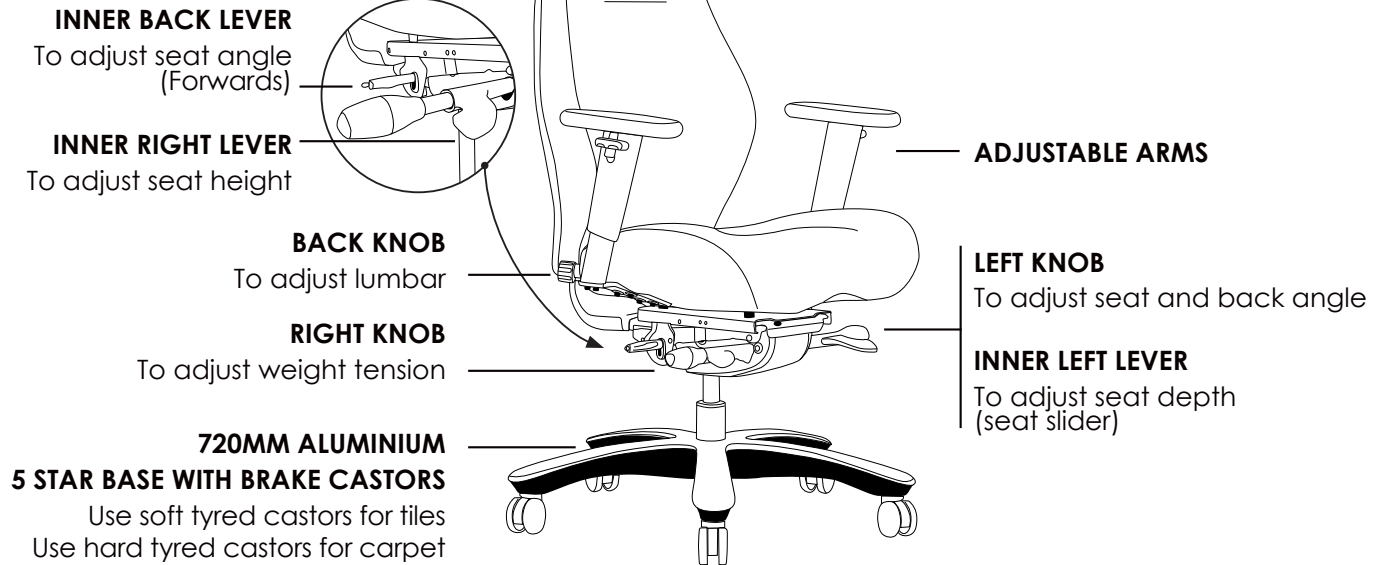

X Do not use as a step ladder

DIMENSIONS: (mm)

BACK **BACK TO FLOOR**
W: 475 Lowest: 1060
H: 615 Highest: 1180

HEADREST **HEADREST TO FLOOR**
W: 260 Lowest: 1240
H: 180 Highest: 1360

SEAT **SEAT TO FLOOR**
W: 540 Lowest: 505
D: 490 Highest: 625

ARM TO FLOOR
Lowest: 675
Highest: 875



CONTROL-H



CONTROL-L



back view

** Please note that the Headrest should not be used to manoeuvre the chair.*

Features:

- Adjustable seat height
- Adjustable seat and back angle
- Foward seat tilt adjustment
- Adjustable seat depth (seat slider)
- Adjustable weight tension

- Adjustable lumbar support
- Adjustable arms
- Moulded seat and back foam
- Saddle seat
- Synchron mechanism with 3 locking positions

- 720mm aluminium 5 star base
- Brake castors
- Available in local fabrics
- AFRDI tested to level 6
- Suitable for indoor use only

WARRANTY 7 Year

WEIGHT LIMIT 200 Kilogram

UPHOLSTERED IN AUSTRALIA

AFRDI MEMBER

furnitech

Australian Furniture Research & Development Institute

AFRDI 142 Certification 160KG MULTI SHIFT USE

REGAL RANGE

INSTRUCTION OF USE

INDOOR USE ONLY

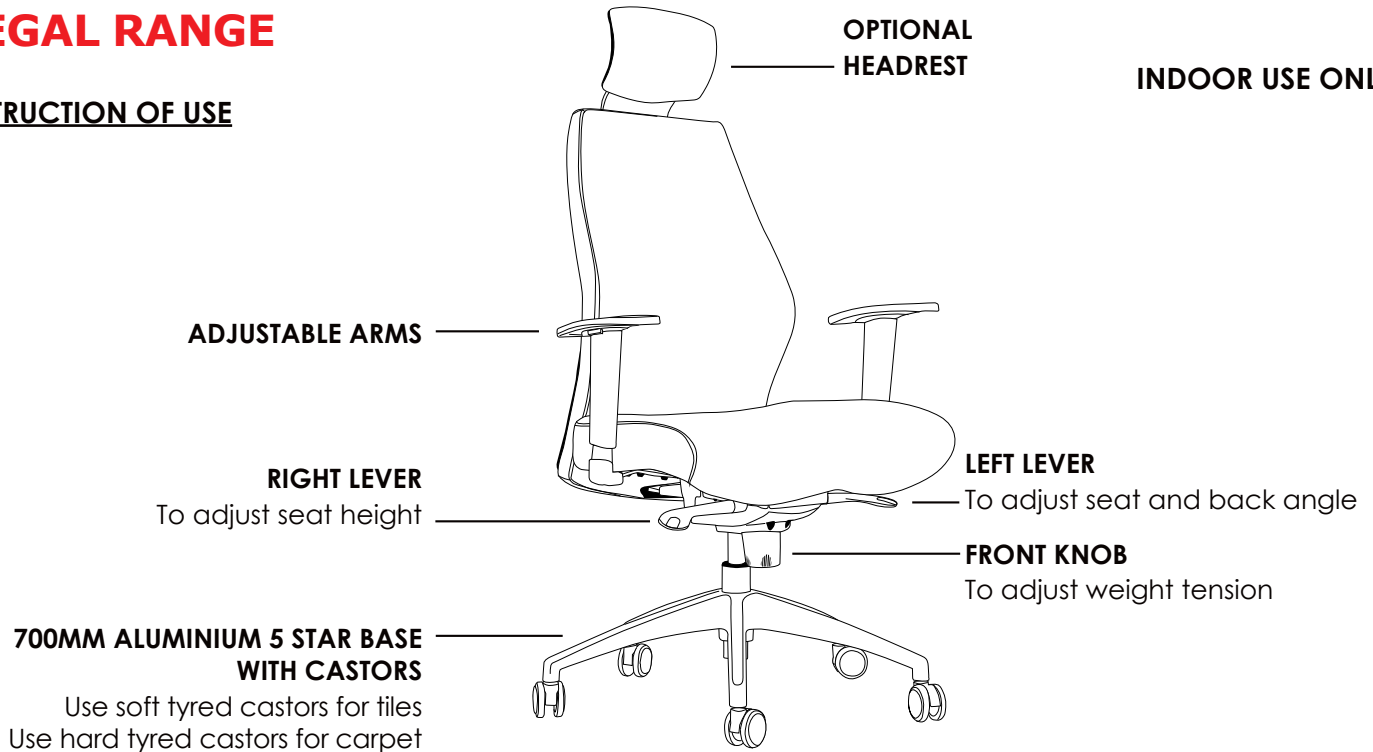

X Do not use as a step ladder

DIMENSIONS: (mm)

BACK **BACK TO FLOOR**
W: 500 Lowest: 1020
H: 570 Highest: 1080

HEADREST **HEADREST TO FLOOR**
W: 260 Lowest: 1210
H: 180 Highest: 1270

SEAT **SEAT TO FLOOR**
W: 525 Lowest: 470
D: 470 Highest: 530

ARM TO FLOOR
Lowest: 640
Highest: 780



REGAL-H



REGAL-L



back view

** Please note that the Headrest should not be used to manoeuvre the chair.*

Features:

Adjustable seat height
Adjustable seat and back angle
Adjustable weight tension
Adjustable chrome arms

Moulded back foam
Saddle seat
Synchron mechanism with 3 locking positions
700mm aluminium 5 star base

Available in local fabrics
Suitable for indoor use only



VENTI RANGE

INSTRUCTION OF USE

INDOOR USE ONLY

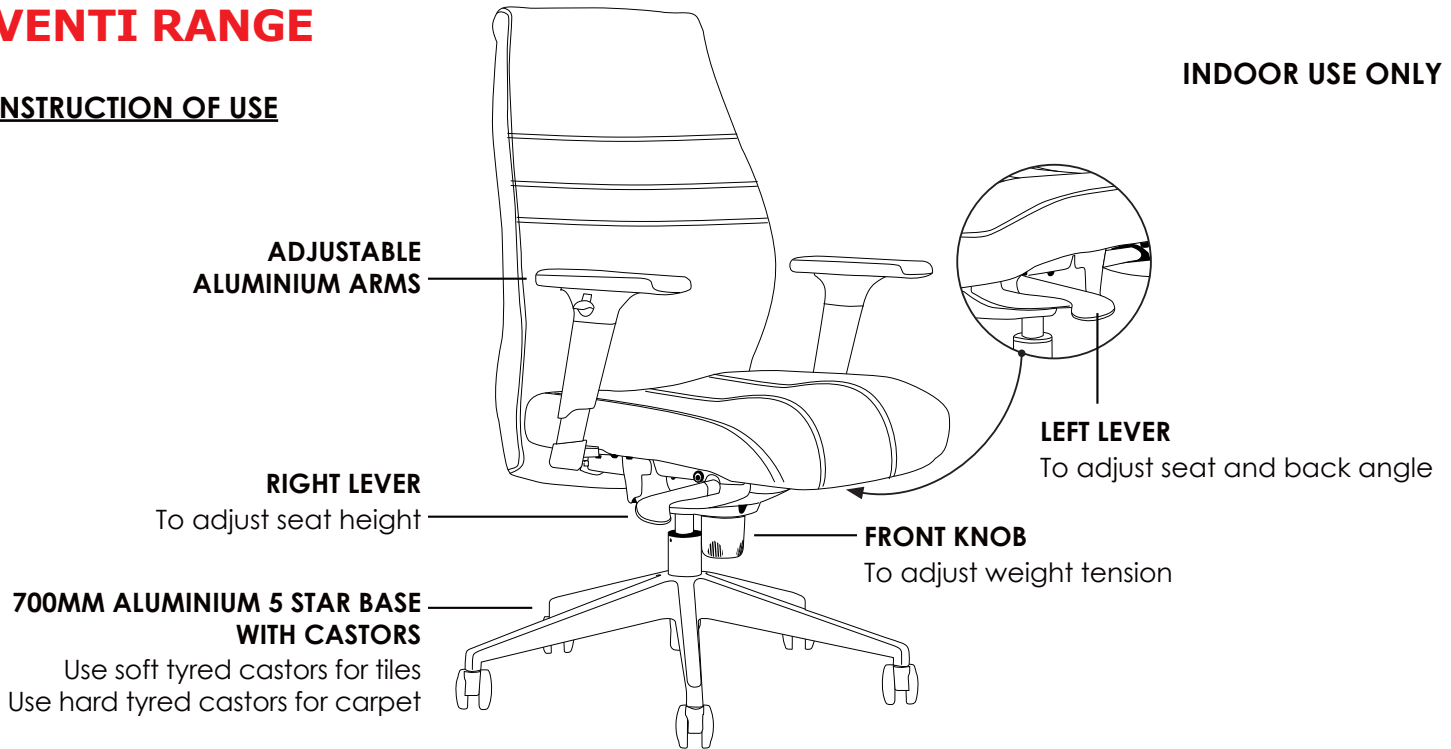

X Do not use as a step ladder

DIMENSIONS: (mm)

LOW BACK	BACK TO FLOOR	HIGH BACK	BACK TO FLOOR	SEAT	SEAT TO FLOOR	ARM TO FLOOR
W: 480	Lowest: 1025	W: 500	Lowest: 1170	W: 510	Lowest: 455	Lowest: 640
H: 580	Highest: 1085	H: 720	Highest: 1230	D: 520	Highest: 515	Highest: 770

Fabric: Lana carbon



VENTI-H



VENTI-L



back view

Features:

Adjustable seat height
Adjustable seat and back angle
Adjustable weight tension
Adjustable aluminium arms

High density foam
Synchron mechanism with 3 locking positions
700mm aluminium 5 star base

Available in local fabrics
Suitable for indoor use only



AVANTI RANGE

INSTRUCTION OF USE

INDOOR USE ONLY

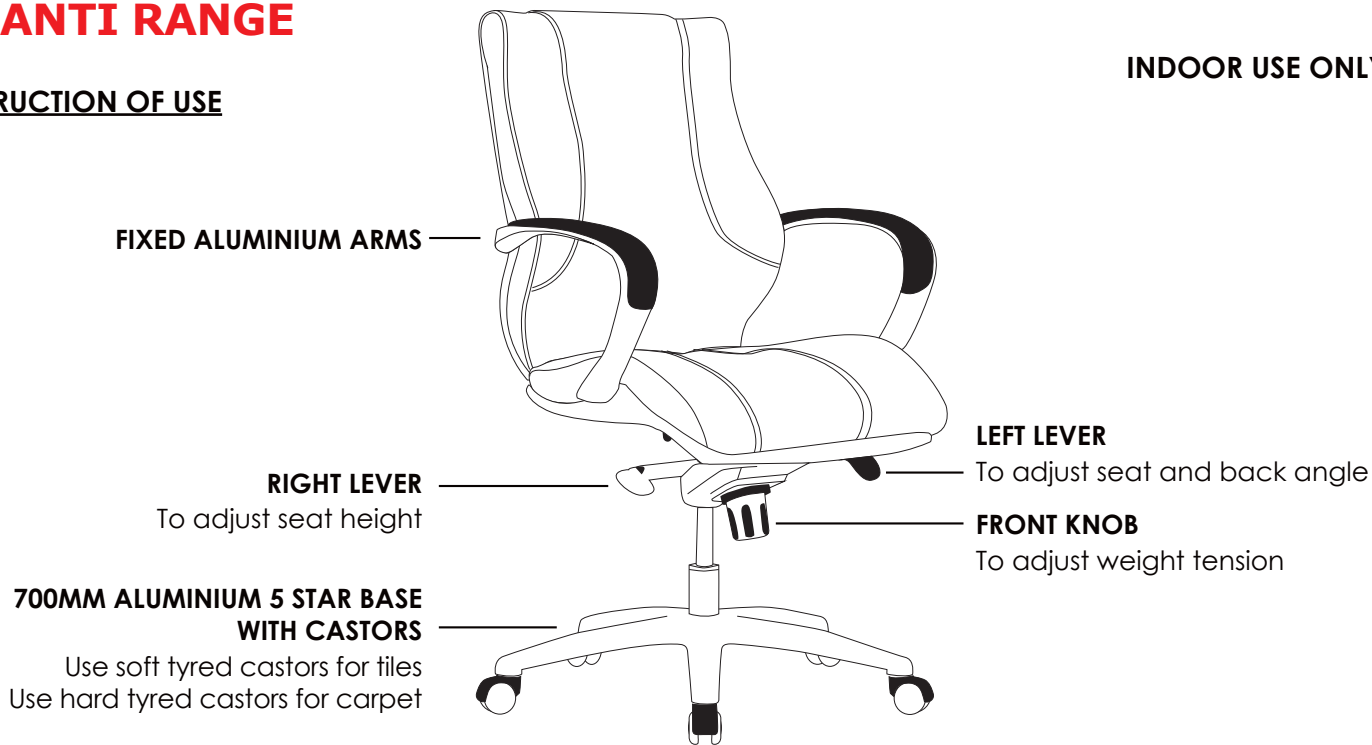

X Do not use as a step ladder

DIMENSIONS: (mm)

LOW BACK **BACK TO FLOOR**
W: 500 Lowest: 1045
H: 570 Highest: 1125

HIGH BACK **BACK TO FLOOR**
W: 500 Lowest: 1190
H: 730 Highest: 1270

SEAT **SEAT TO FLOOR**
W: 510 Lowest: 510
D: 530 Highest: 590

ARM TO FLOOR
Lowest: 710
Highest: 790

Fabric: Lana carbon



AVANTI-H



AVANTI-L



back view

Features:

Adjustable seat height
Adjustable seat and back angle
Adjustable weight tension
Fixed aluminium arms

High density foam
Knee tilt mechanism with 3 locking positions
700mm aluminium 5 star base

Available in local fabrics
Suitable for indoor use only



KOMBO RANGE

INDOOR USE ONLY

INSTRUCTION OF USE

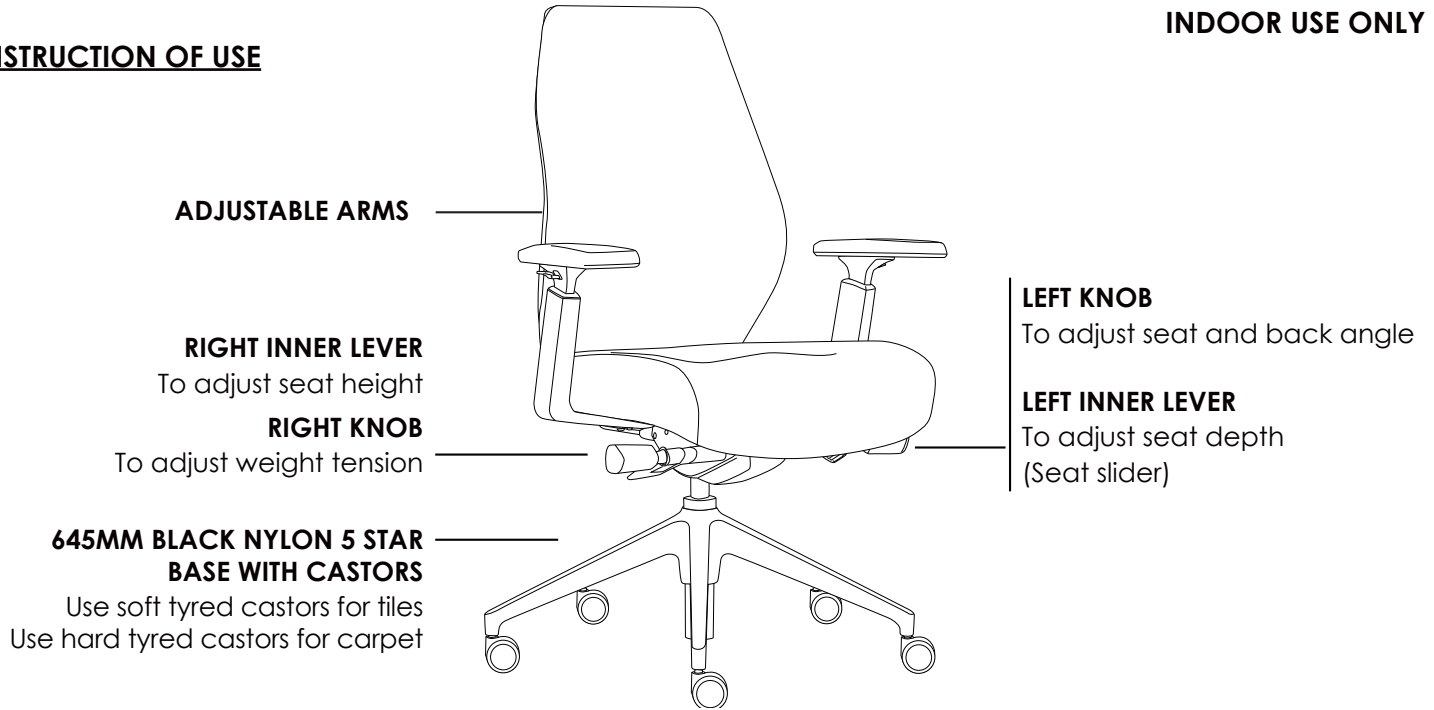

X Do not use as a step ladder

DIMENSIONS: (mm)

LOW BACK	BACK TO FLOOR	HIGH BACK	BACK TO FLOOR	SEAT	SEAT TO FLOOR	ARM TO FLOOR
W: 520	Lowest: 1100	W: 520	Lowest: 1250	W: 515	Lowest: 470	Lowest: 660
H: 610	Highest: 1160	H: 760	Highest: 1310	D: 480	Highest: 530	Highest: 720



KOMBO-H



KOMBO-L



back view

Features:

Adjustable seat height
Adjustable seat and back angle
Adjustable seat depth (seat slider)
Adjustable weight tension

Adjustable arms
Moulded back foam
Big boy seat
Memory seat foam

Synchron mechanism with 3 locking positions
645mm black nylon 5 star base
Available in local fabrics
Suitable for indoor use only



ASSIST RANGE

INSTRUCTION OF USE

INDOOR USE ONLY

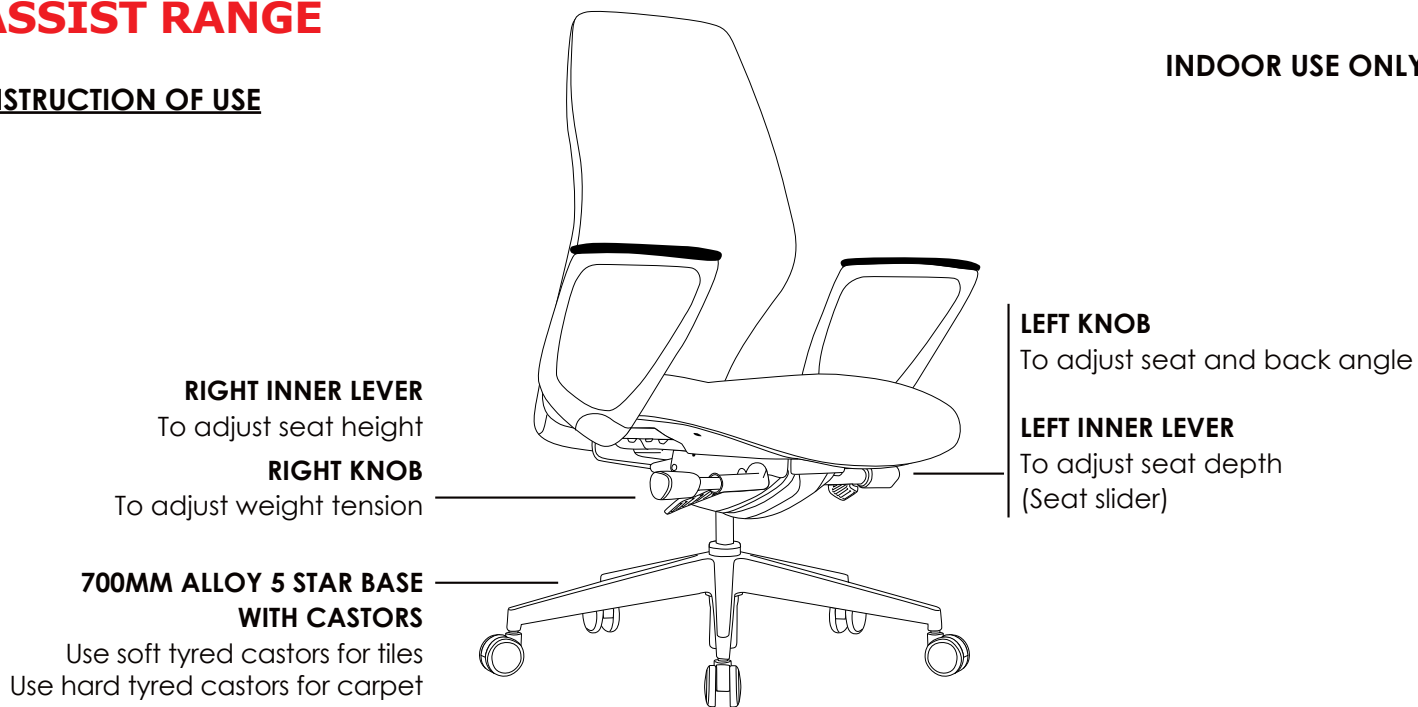

X Do not use as a step ladder

DIMENSIONS: (mm)

LOW BACK **BACK TO FLOOR**
W: 520 Lowest: 1000
H: 610 Highest: 1080

HIGH BACK **BACK TO FLOOR**
W: 520 Lowest: 1185
H: 760 Highest: 1265

SEAT **SEAT TO FLOOR**
W: 520 Lowest: 450
D: 520 Highest: 530

ARM TO FLOOR
Lowest: 650
Highest: 710



ASSIST-H



ASSIST-L



back view

Features:

Adjustable seat height
Adjustable seat and back angle
Adjustable seat depth (seat slider)
Adjustable weight tension

Fixed aluminium arms
Plastic under pan
Moulded seat and back foam
Synchron mechanism with 3 locking positions

700mm alloy 5 star base
Available in local fabrics
Suitable for indoor use only



FOCUS RANGE



FOC-1U



FOC-1UA

DIMENSIONS: (mm)

BACK	SEAT	OVERALL	ARM WIDTH	TABLET ARM	ARM TO FLOOR	TABLET ARM TO FLOOR
W: 490 H: 435	W: 465 D: 440	H: 840 D: 550 W: 525	Inner: 510 Outer: 610	W: 610 D: 660	H: 680	H: 745 Flip up: 1010



FOC-1UTR



FOC-1UTL

Features:

Multi purpose stackable client chair
Not stackable with tablet arms
Optional black metal trolley
Linkable except with arms or tablet arm
Fully strengthened plastic back shell

Fully welded frame
BIFMA drop tested
Available in local fabrics
Suitable for indoor use only
Do not use as a step ladder



VINN RANGE



VINN-BU



VINN-BUA



VINN-BUT



VINN-BU-ST

Available with arms

DIMENSIONS: (mm)

BACK	SEAT	OVERALL	STOOL OVERALL	ARM WIDTH	ARM TO FLOOR	TABLET ARM	TABLET ARM TO FLOOR
W: 435 H: 390	W: 455 D: 435	H: 830 D: 545 W: 530	H: 1030 D: 540 W: 555	Inner: 485 Outer: 570	H: 665	W: 380 D: 290	H: 695 Flip up: 900

Fabric: Chelsea camilia



VINN-MBU



VINN-MBUA



VINN-MBUT



VINN-MBU-ST

Features:

- Stackable
- Not stackable with tablet arms/stool with arms
- Optional black metal trolley
- Linkable except with arms or tablet arm
- Plastic under pan

- Solid steel sled base frame
- Available in local fabrics
- Suitable for indoor use only
- Do not use as a step ladder

Optional:



Colour mesh
(Jazz mesh range)

Trolley available



POD RANGE



POD-B-NL



POD-R-BL



POD-W-BB



POD-B-BBC

DIMENSIONS: (mm)

SHELL	NL/BL	NL/BL SEAT TO FLOOR	BB	BB SEAT TO FLOOR	BB BACK TO FLOOR	BBC	BBC SEAT TO FLOOR	BBC BACK TO FLOOR
H: 380	H: 810	H: 460	D: 520	Lowest: 410	Lowest: 760	D: 520	Lowest: 460	Lowest: 810
D: 400	D: 460	H: 460	W: 520	Highest: 530	Highest: 880	W: 520	Highest: 580	Highest: 930
W: 425	W: 415							

Fabric: Lana carbon

Plastic colour option:

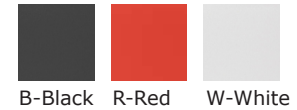

POD-RU-NL



POD-WU-BL



POD-BU-BB



POD-RU-BBC

Features:

Not stackable
Adjustable seat height
(With black base and
black base with castors only)

Available in local fabrics
Suitable for indoor use only
Do not use as a step ladder



Optional:



Plastic shell



With
Upholstered

POD RANGE



POD-4BU



POD-4RUA



POD-4WUT



POD-STBU

DIMENSIONS: (mm)

SHELL	STOOL OVERALL	ARM WIDTH	TABLET ARM	4 LEG: OVERALL	WITH ARM TO FLOOR	SLED: OVERALL	WITH ARM TO FLOOR
H: 380	H: 1025	Inner: 440	W: 380	H: 820	H: 660	H: 830	H: 670
D: 400	D: 530	Outer: 540	D: 280	D: 510	WITH TABLET ARM TO FLOOR	D: 530	WITH TABLET ARM TO FLOOR
W: 425	W: 500			W: 470	H: 700	W: 480	H: 710
					Flip up: 980		Flip up: 990

Plastic colour option:

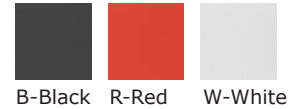

POD-SRU



POD-SWUA



POD-SBUT

Features:

Stackable
Not stackable with arms or tablet arm
Linkable with sled base
(Except with arms or tablet arm)

Plastic under pan
Available in local fabrics
Suitable for indoor use only
Do not use as a step ladder



MAXI RANGE



M1



M1-C



M4



M4-C

DIMENSIONS: (mm)

BACK	SEAT	4 LEG SEAT TO FLOOR	4 LEG BACK TO FLOOR	4 LEG OVERALL	SLED SEAT TO FLOOR	SLED BACK TO FLOOR	SLED OVERALL	4 LEG ARM TO FLOOR	SLED ARM TO FLOOR
W: 440 H: 370	W: 460 D: 490	H: 465	H: 810	H: 810 D: 460 W: 520	H: 470	H: 805	H: 805 D: 620 W: 570	H: 630	H: 630

Fabric: Chelsea gazebo



MM1



MM1-C



MM4



MM4-C

Features:

Stackable
(Sled base with no arms only)
Plastic under pan
Plastic outer back
(upholstered back only)

Available in local fabrics
AFRDI approved to level 6
Suitable for indoor use only
Do not use as a step ladder



Optional:



Colour mesh
(Jazz mesh range)



Fixed arm

VERA RANGE



VC100



VC100-C



VC400



VC400-C

DIMENSIONS: (mm)

ROUND BACK	SQUARE BACK	SEAT
W: 450	W: 450	W: 450
H: 330	H: 380	D: 460

4 LEG:

WITH ROUND BACK OVERALL	WITH SQUARE BACK OVERALL	ARM TO FLOOR	SEAT TO FLOOR
H: 800	H: 850	H: 650	H: 480
D: 490	D: 490		
W: 495	W: 495		

TABLET ARM TO FLOOR
H: 770
Flip up: 1045

SLED:

WITH ROUND BACK OVERALL	WITH SQUARE BACK OVERALL	ARM TO FLOOR	SLED TABLET ARM TO FLOOR
H: 800	H: 850	H: 650	H: 770
D: 625	D: 625	SEAT TO FLOOR	Flip up: 1045
W: 520	W: 520	H: 480	



OGVC100



OGVC100-C



OGVC400



OGVC400-C



Features:

Stackable
Not stackable with arms or tablet arm
Heavy duty metal frame

Available in local fabrics
Suitable for indoor use only
Do not use as a step ladder

Optional:



With arm



With left tablet arm



With right tablet arm

MAXI BEAM

Optional:



Fully Upholstered back



Mesh back



Colour mesh with mesh back (Jazz mesh range)

WEIGHT LIMIT
200
Kilogram



M-BEAM 2

WEIGHT LIMIT
300
Kilogram



MM-BEAM 3

WEIGHT LIMIT
350
Kilogram



M-BEAM 4



Features:

Plastic under pan
Plastic outer back (upholstered back only)
Black metal frame

Adjustable feet
Available in local fabrics
Suitable for indoor use only
Do not use as a step ladder

DIMENSIONS: (mm)

BEAM 2	BEAM 3	BEAM 4	SEAT TO FLOOR
W: 1190	W: 1720	W: 2170	H: 430
H: 830	H: 830	H: 830	
D: 660	D: 660	D: 660	

FOCUS BEAM

WEIGHT LIMIT
200
Kilogram



F-BEAM 2U

WEIGHT LIMIT
300
Kilogram



F-BEAM 3U

Features:

Fully welded black metal frame
Twin seat support bars
Adjustable feet

Available in local fabrics
Suitable for indoor use only
Do not use as a step ladder

DIMENSIONS: (mm)

F-BEAM 2U
W: 1020
H: 890
D: 570

F-BEAM 3U
W: 1570
H: 890
D: 570

SEAT TO FLOOR
H: 410



VINN BEAM

Optional:



Upholstered
Plastic back



Mesh back



Colour mesh
with mesh back
(Jazz mesh range)

WEIGHT LIMIT
180
Kilogram



V-BEAM 2U

WEIGHT LIMIT
250
Kilogram



V-BEAM 3MU

WEIGHT LIMIT
300
Kilogram



V-BEAM 4U

Features:

Heavy duty black metal frame
Black plastic
Adjustable feet

Available in local fabrics
Suitable for indoor use only
Do not use as a step ladder



DIMENSIONS: (mm)

BEAM 2	BEAM 3	BEAM 4	SEAT TO FLOOR
W: 1060	W: 1530	W: 2020	H: 455
H: 825	H: 825	H: 825	
D: 510	D: 510	D: 510	

POD BEAM

Plastic colour option:



WEIGHT LIMIT
200
Kilogram



P-BEAM 2BU

WEIGHT LIMIT
300
Kilogram



P-BEAM 3RU

WEIGHT LIMIT
350
Kilogram



P-BEAM 4WU

Features:

Heavy duty black metal frame
Adjustable feet
Available in local fabrics

Suitable for indoor use only
Do not use as a step ladder



DIMENSIONS: (mm)

BEAM 2	BEAM 3	BEAM 4	SEAT TO FLOOR
W: 1060	W: 1530	W: 2020	H: 475
H: 825	H: 825	H: 825	
D: 510	D: 510	D: 510	

SMOKE RANGE



SMOKE-4L



SMOKE-SB



SMOKE-SBB



SMOKE-AB

DIMENSIONS: (mm)

SHELL	4L	4L SEAT TO FLOOR	SB/SBB	SB/SBB SEAT TO FLOOR	NL/BL	NL/BL SEAT TO FLOOR	AB SEAT TO FLOOR	BB SEAT TO FLOOR	BBC SEAT TO FLOOR
H: 410	H: 830	H: 455	H: 830	H: 455	H: 800	H: 410	Lowest: 445	Lowest: 425	Lowest: 475
D: 400	D: 500		D: 490		D: 520		Highest: 560	Highest: 545	Highest: 595
W: 470	W: 530		W: 530		W: 520		AB BACK TO FLOOR	BB BACK TO FLOOR	BBC BACK TO FLOOR
							Lowest: 820	Lowest: 815	Lowest: 865
							Highest: 935	Highest: 935	Highest: 985



SMOKE-NL



SMOKE-BL



SMOKE-BB



SMOKE-BBC



Features:

Adjustable seat height
(With 4 star base, black base and
black base with castors only)

Fully upholstered
High density foam
Plywood shell

Available in local fabrics
Suitable for indoor use only
Do not use as a step ladder

SAL RANGE



SAL



side view



back view

Features:

Fully upholstered
High density foam
Black metal frame

Available in local fabrics
Suitable for indoor use only
Do not use as a step ladder

DIMENSIONS: (mm)

OVERALL	BACK	SEAT	SEAT TO FLOOR
H: 695	W: 590	W: 625	H: 415
D: 645	H: 365	D: 350	
W: 670			



LUSH RANGE



LUSH



side view

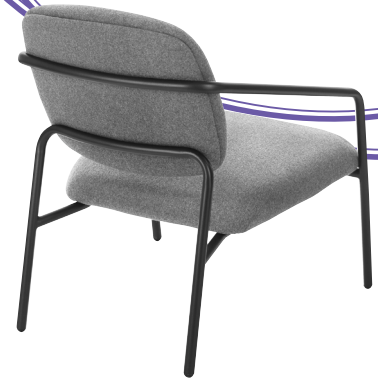

back view

Features:

Fully upholstered
High density foam
Black metal frame

Available in local fabrics
Suitable for indoor use only
Do not use as a step ladder

DIMENSIONS: (mm)

OVERALL	BACK	SEAT	SEAT TO FLOOR
H: 820	W: 525	W: 620	H: 430
D: 745	H: 385	D: 530	
W: 680			



CUPPA RANGE



CUPPA



side view



back view

Features:

Fully upholstered
High density foam
Black metal frame

Available in local fabrics
Suitable for indoor use only
Do not use as a step ladder

DIMENSIONS: (mm)

OVERALL	INNER	SEAT	SEAT TO FLOOR
H: 795	WIDTH	W: 705	H: 460
D: 680	W: 550	D: 520	
W: 780			



VERO RANGE



VERO-STB



VERO-STT



VERO-CHB



VERO-CHT

Features:

Plywood inner structure
Metal frame
High density foam

Available in local fabrics
Suitable for indoor use only
Do not use as a step ladder

DIMENSIONS: (mm)

**STOOL
OVERALL**
H: 910
D: 500
W: 485

**STOOL
SEAT TO
FLOOR**
H: 680

**CHAIR
OVERALL**
H: 750
D: 680
W: 560

**CHAIR
SEAT TO
FLOOR**
H: 430



GOLD RANGE



GOLD-4L



GOLD-SB



GOLD-SBB



GOLD-AB

DIMENSIONS: (mm)

SHELL	4L	4L SEAT TO FLOOR	SB/SBB	SB/SBB SEAT TO FLOOR	NL/BL	NL/BL SEAT TO FLOOR	AB SEAT TO FLOOR	BB SEAT TO FLOOR	BBC SEAT TO FLOOR
H: 400	H: 800	H: 490	H: 810	H: 500	H: 790	H: 430	Lowest: 400	Lowest: 445	Lowest: 495
D: 440	D: 540		D: 540		D: 520		Highest: 480	Highest: 565	Highest: 615
W: 640	W: 640		W: 640		W: 640		AB BACK TO FLOOR	BB BACK TO FLOOR	BBC BACK TO FLOOR
							Lowest: 780	Lowest: 805	Lowest: 855
							Highest: 860	Highest: 925	Highest: 975



GOLD-NL



GOLD-BL



GOLD-BB



GOLD-BBC



Features:

Adjustable seat height
(With 4 star base, black base and
black base with castors only)

High density foam
Plywood shell
Available in local fabrics

Suitable for indoor use only
Do not use as a step ladder

JUNE RANGE



JUNE



side view



back view

Features:

Adjustable seat height
High density foam
700mm aluminium 4 star base
Plywood shell

Available in local fabrics
Suitable for indoor use only
Do not use as a step ladder



DIMENSIONS: (mm)

SHELL	INNER WIDTH	SEAT TO FLOOR	BACK TO FLOOR
H: 365		Lowest: 465	Lowest: 745
D: 480	W: 435	Highest: 600	Highest: 880
W: 560			

TIME RANGE



Features:

Adjustable seat height
(With black base and black base with castors only)
High density foam
Moulded back foam

Plywood shell
Available in local fabrics
Suitable for indoor use only
Do not use as a step ladder

DIMENSIONS: (mm)

SB/SBB	NL/BI
H: 755	H: 760
D: 500	D: 520
W: 640	W: 640
SEAT TO FLOOR	SEAT TO FLOOR
H: 450	H: 440

BB SEAT TO FLOOR

Lowest: 455
Highest: 575

BB BACK TO FLOOR

Lowest: 775
Highest: 895

BBC SEAT TO FLOOR

Lowest: 505
Highest: 625

BBC BACK TO FLOOR

Lowest: 825
Highest: 945



OPERA RANGE



OPERA-4L



OPERA-TL



OPERA-AB

Features:

- Loose back and seat cushions
- Moulded foam on steel frame
- Available in local fabrics
- Suitable for indoor use only
- Do not use as a step ladder



DIMENSIONS: (mm)

BACK CUSHION	SEAT CUSHION	4L OVERALL	SEAT TO FLOOR	TL OVERALL	SEAT TO FLOOR	AB OVERALL	SEAT TO FLOOR
H: 400	H: 510	H: 850	H: 440	H: 850	H: 440	H: 850	H: 480
W: 580	W: 540	D: 610		D: 670		D: 700	
		W: 740		W: 740		W: 740	

LEAF RANGE



LEAF-L



LEAF-H

LEAF-T

MDF white top

Chrome frame

Suitable for indoor use only

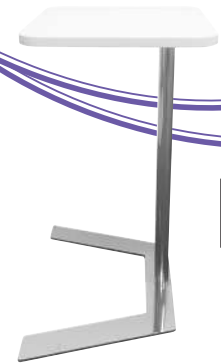

LEAF-T

Features:

High density foam
Loose back cushion
Metal frame
Adjustable feet

Available in local fabrics
Suitable for indoor use only
Do not use as a step ladder



DIMENSIONS: (mm)

LEAF-L OVERALL

H: 830
D: 650
W: 880

LEAF-H OVERALL

H: 1240
D: 650
W: 880

SEAT TO FLOOR

H: 430

TABLE OVERALL

H: 610
D: 330
W: 470

PLAY RANGE



PLAY-1



PLAY-2



Features:

High density foam
Solid timber frame
Plastic legs

Available in local fabrics
Suitable for indoor use only
Do not use as a step ladder

DIMENSIONS: (mm)

PLAY-1	PLAY-2
H: 425	H: 425
D: 430	D: 450
W: 430	W: 685



OLA RANGE



OLA-T



OLA-R



OLA-S

Features:

High density foam
Solid timber frame
Plastic legs

Available in local fabrics
Suitable for indoor use only
Do not use as a step ladder

DIMENSIONS: (mm)

OLA-T
H: 455
D: 480
W: 540

OLA-R
H: 455
Dia: 550

OLA-S
H: 455
D: 550
W: 550



CLIP RANGE



CLIP



Features:

Zig zag steel spring
Solid hardwood frame
Webbed base
Chrome legs

Available in local fabrics
Suitable for indoor use only
Do not use as a step ladder

DIMENSIONS: (mm)

H: 410
D: 600
W: 720



IMPRESS RANGE



IMPRESS-1



IMPRESS-2



IMPRESS-T

IMPRESS-T

8mm Tempered glass top
Chrome legs
Suitable for indoor use only

Features:

Moulded polyurethane foam
Solid hardwood frame
Zinc legs

Available in local fabrics
Suitable for indoor use only
Do not use as a step ladder



DIMENSIONS: (mm)

IMPRESS-1

H: 680
D: 510
W: 590

IMPRESS-2

H: 400
D: 610
W: 650

IMPRESS-T

H: 400
D: 470
W: 600

RADIUS RANGE



RADIUS-1



RADIUS-2



Features:

Moulded polyurethane foam
Zinc legs
Available in local fabrics

Suitable for indoor use only
Do not use as a step ladder

DIMENSIONS: (mm)

H: 420
Dia: 630



BAR STOOLS



GAMMA



LIFT



VEGAS



FLOW

Gamma, Vegas features:

- Solid rod chrome frame
- Available in local fabrics
- Suitable for indoor use only
- Do not use as a step ladder

Lift, Flow features:

- Adjustable seat height
- Solid steel stain base
- Foot rest
- Available in local fabrics
- Suitable for indoor use only
- Do not use as a step ladder



DIMENSIONS: (mm)

GAMMA	LIFT	VEGAS	FLOW
H: 695	H: 530-780	H: 980	H: 735-985
D: 480	D: 410	D: 520	D: 400
W: 460	W: 400	W: 510	W: 450

BLITZ RANGE



BLITZ-U



side view



back view

Features:

High density foam
Zig zag steel spring
Plywood frame
Chrome feet

Available in local fabrics
Suitable for indoor use only
Do not use as a step ladder

DIMENSIONS: (mm)

BACK	SEAT	SEAT TO FLOOR	OVERALL
W: 600	W: 610	H: 410	H: 750
H: 350	D: 525		D: 750
			W: 610



TWIST RANGE

Fabric: Lana grey, lana fire



TWIST-OT



TWIST-SO



TWIST-SI

Features:

High density foam
Plywood frame
Webbed base
Chrome feet

Available in local fabrics
Suitable for indoor use only
Do not use as a step ladder

DIMENSIONS: (mm)

TWIST-OT
W: 930
H: 425
D: 740

TWIST-SO
W: 950
H: 750
D: 760

TWIST-SI
W: 940
H: 750
D: 760

**SO/SI
SEAT TO FLOOR**
425



MONTAGE RANGE

WEIGHT LIMIT
390
Kilogram



MO-3S

WEIGHT LIMIT
260
Kilogram



MO-2S

WEIGHT LIMIT
130
Kilogram



MO-1S

Features:

Pocket spring seat
Loose cushions upholstered both sides
Zig zag steel spring
Webbed base
Solid hardwood frame

Stainless steel feet
Available in local fabrics
Suitable for indoor use only

DIMENSIONS: (mm)

MO-1S	MO-2S	MO-3S	ARM TO FLOOR
W: 835	W: 1400	W: 1970	655
H: 740	H: 740	H: 740	SEAT TO FLOOR
D: 790	D: 790	D: 790	475



CONCEPT RANGE

Fabric: Lana carbon

WEIGHT LIMIT
360
Kilogram



CON-3

WEIGHT LIMIT
240
Kilogram



CON-2

WEIGHT LIMIT
120
Kilogram



CON-1

Features:

High density foam
Zig zag steel spring
Plywood frame

Black metal arm and feet
Available in all local fabrics
Suitable for indoor use only

WARRANTY
5
Year

WEIGHT LIMIT
120
Kilogram

WEIGHT LIMIT
240
Kilogram

WEIGHT LIMIT
360
Kilogram

UPHOLSTERED
IN AUSTRALIA

DIMENSIONS: (mm)

CON-1
W: 688
H: 750
D: 810

CON-2
W: 1285
H: 750
D: 810

CON-3
W: 1885
H: 750
D: 810

ARM TO FLOOR
605

SEAT TO FLOOR
410

SHELL RANGE

Shell fabric: Jack flame
Cushion fabric: Bolton chili



SHELL-1S



SHELL-1SH



SHELL-2S



SHELL-2SH

Features:

- Australian made
- High density foam
- Loose cushions upholstered both sides
- Timber frame
- Aluminum legs
- Available in local fabrics
- Suitable for indoor use only

DIMENSIONS: (mm)

SHELL-1S	SHELL-1SH	SHELL-2S	SHELL-2SH	ARM TO FLOOR
W: 890	W: 920	W: 1490	W: 1510	730
H: 865	H: 1210	H: 865	H: 1210	SEAT TO FLOOR
D: 840	D: 840	D: 840	D: 840	500



ACOUSTIC SCREENS

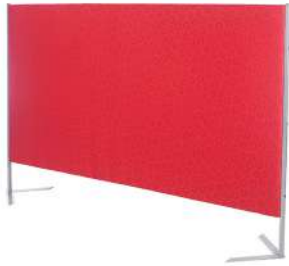

FAS-1218



FAS-1518



FAS-1818

Features:

- Australian made
- Solid timber frame
- Frames wrapped with a 10mm layer of foam
- Frames wrapped with a layer of cardboard

- 19mm metal side frame
- Available in local fabrics
- Suitable for indoor use only

DIMENSIONS: (mm)

FAS-1218	FAS-1518	FAS-1818
W: 1800	W: 1800	W: 1800
H: 1200	H: 1500	H: 1800



STATE RANGE

INSTRUCTION OF USE



ST003

Features:

Adjustable seat height
Optional glides or brake castors
600mm black nylon 5 star base

Available in local fabrics
Suitable for indoor use only
Do not use as a step ladder

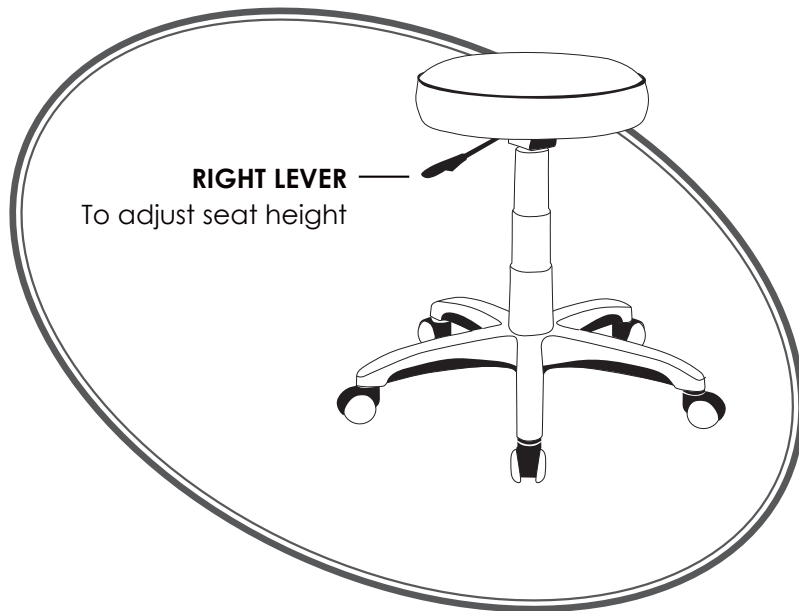

Optional drafting kit

DIMENSIONS: (mm)

SEAT	SEAT TO FLOOR
Dia: 370	Lowest: 470
	Highest: 600

FABRIC OPTIONS

*Fabric card available, please contact our office for the copy

JAZZ RANGE

METRO RANGE



BLACK



MIDNIGHT

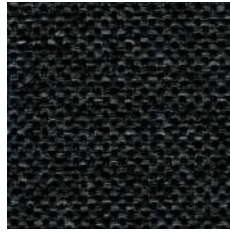

CHARCOAL



SILVER



METRO INK

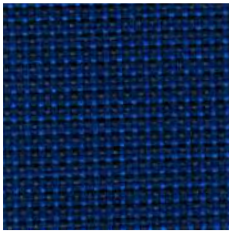

INDIGO

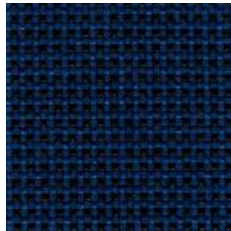

TURQUOISE

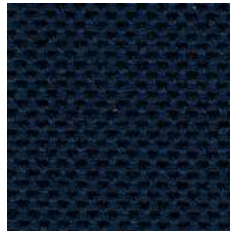

NAVY

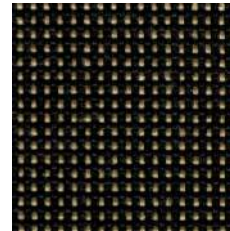

GOLD



METRO BLACK

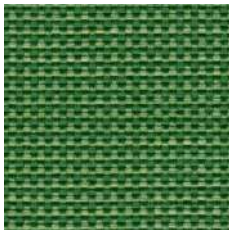

APPLE

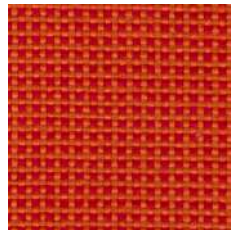

ORANGE

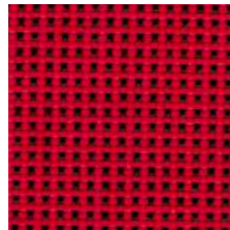

CRIMSON

JAZZ MESH RANGE

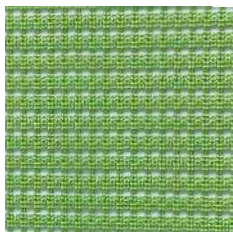

MINT



CITRUS

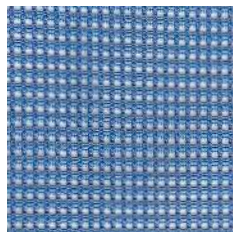

OCEAN



HOT

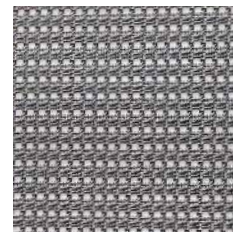

SLATE

LOOP RANGE



AQUA



SEA



BLACK



MIST

SPADE RANGE

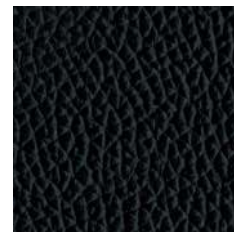

BLACK LEATHER

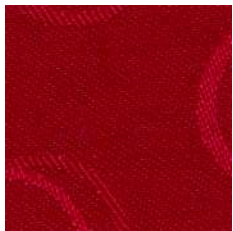

RED



TREE



LIME



DUST

SPADE RANGE

LANA WOOL RANGE



BLACK VINYL



STEEL

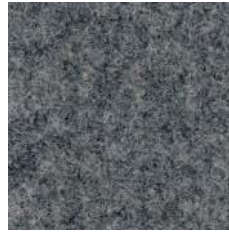

GREY

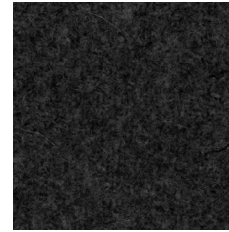

CARBON



SAND



RED VINYL



SKY



WAVE

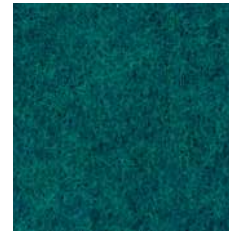

TEAL



SAPPHIRE



WHITE VINYL



WINE



FIRE



FOREST