



SHARP
OFFICE

**EXECUTIVE & FUNCTIONAL
OFFICE SEATING**

CATALOGUE
2024-2025

Effective on 01/07/2024



Warranty period for chairs and lounges



Weight rating for individual chairs and lounges*



Fully imported Chairs, lounges, parts and components.



The Performance criteria adopted for certification by Furntech is based on Australian standards, e.g. Level 6 - Severe commercial and heavy industrial.*

**Weight limits are self-rated by Style Ergonomic Australia. AFRDI approved chairs are normally rated to 110kg.*

AFRDI 142
Certification



AFRDI rating for multi shift use and 160kg weight limit.



Furntech is an independent not-for-profit technical organisation providing standards, testing product certification and research for buyers and sellers of furniture.



BIFMA is a third-party certification program that provides manufacturers with valuable feedback for evaluating the environmental, human, and social impacts of their furniture products for manufacturing, facility, and organisation.



All instructions of use are instructed while sitting in the chair.

CONTENTS

R1 - TASK MESH SEATING

Intro range	4
Yarra range	6
Rio range.....	8
Hino range	10
Fuse range.....	12
Brent range	14

R2 - TASK SEATING

P350 range	16
Aqua range	18
TR600 range.....	20
Spot range.....	22
Newton range	24

R3 - BOARDROOM SEATING

Trent range.....	26
Dela range.....	28
Gala range	30
Web range.....	32
Volt range	34

R4 - MULTI SHIFT SEATING

Rover range.....	36
Oyster range.....	38
Ranger range.....	40
Impact range.....	42
Raptor range.....	44
Corsa range.....	46
Stanza range.....	48

R5 - EXECUTIVE MESH SEATING

Gibbs range	50
Draft range.....	52
Bolt range.....	54
Miami range.....	56
Bragg range	58
Kube range.....	60
Razor range.....	62
Mitz range	64
Ivory range.....	66
Baxter range	68
Evita range	70
Zodiac range	72
Ergo-1 range.....	74

R6 - EXECUTIVE SEATING

Hilton range.....	76
Cruz range.....	78
Boston range.....	80
Camry range.....	82
Siena range	84
Select range.....	86
Magnum range.....	88
Captain range.....	90

R7 - HOSPITALITY SEATING

Focus range.....	92
Aria range	94
Pod range	95
Vinn range.....	96
Neo range.....	98
Rose range.....	99

R8 - BREAKOUT SEATING

Raven range.....	100
Mia range.....	101
Tonic range	102
Oscar range.....	103
Ram range	104
Nox range	105

R9 - SOFT SEATING

Blitz range.....	106
Rivet range	107
Jaden range	108
Plaza range.....	109

R10 - INDUSTRIAL STOOLS

State range.....	110
Cad range	112
Stage range.....	113

INTRO RANGE

INSTRUCTION OF USE

INDOOR USE ONLY

LEVER

Twist to adjust seat height
Pull to adjust seat and back angle

FRONT KNOB

To adjust weight tension

600MM BLACK NYLON 5 STAR BASE WITH CASTORS

Use soft tyred castors for tiles
Use hard tyred castors for carpet



X Do not use as a step ladder

DIMENSIONS: (mm)

BACK

W: 490

H: 430

BACK TO FLOOR

Lowest: 910

Highest: 1005

SEAT

W: 490

D: 480

SEAT TO FLOOR

Lowest: 480

Highest: 575

ARM TO FLOOR

Lowest: 625

Highest: 720



INTRO-BLACK



Side view



Back view

Features:

Adjustable seat height
Adjustable seat and back angle
Adjustable weight tension

Fixed arms
Butterfly mechanism
600mm black nylon 5 star base

Available in black only
Suitable for indoor use only



YARRA RANGE

INSTRUCTION OF USE

INDOOR USE ONLY

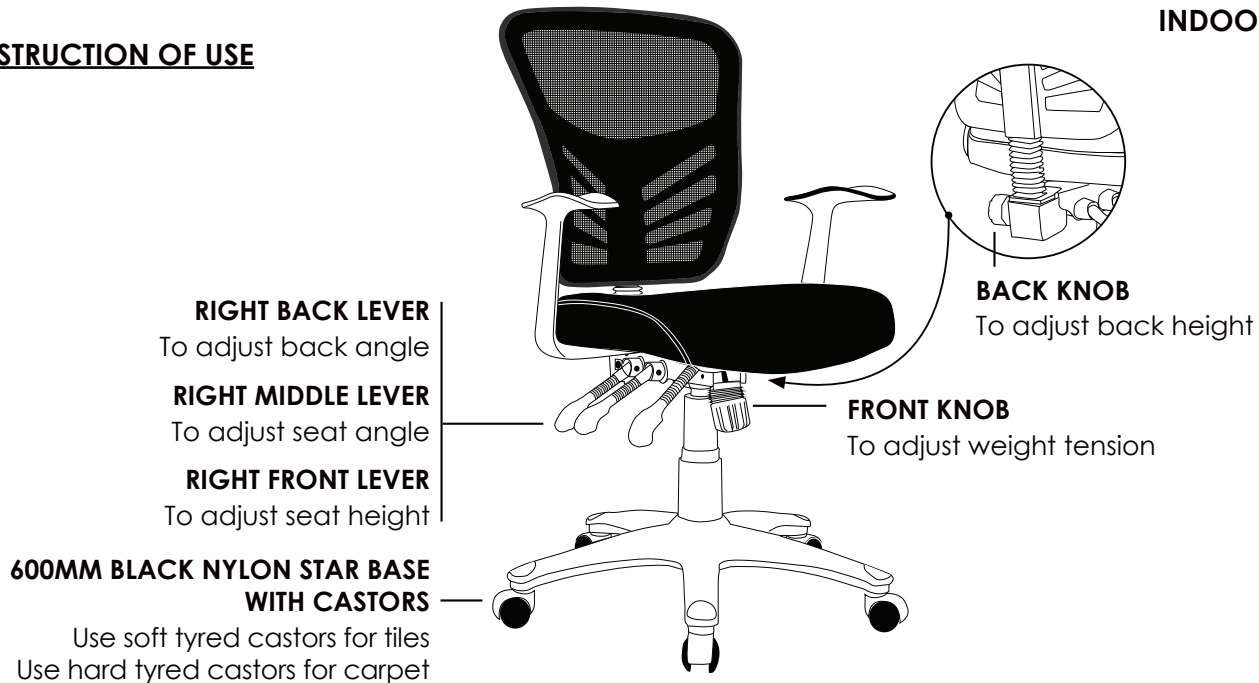

X Do not use as a step ladder

DIMENSIONS: (mm)

BACK

W: 490

H: 510

BACK TO FLOOR

Lowest: 950

Highest: 1050

SEAT

W: 500

D: 515

SEAT TO FLOOR

Lowest: 470

Highest: 570

ARM TO FLOOR

Lowest: 620

Highest: 720



YARRA

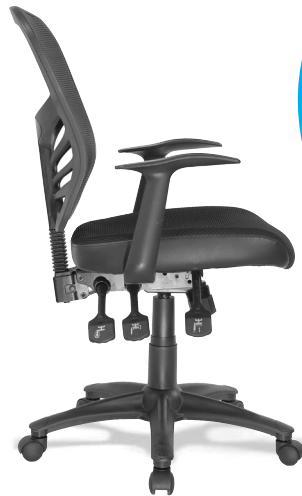

Side view



Back view

Features:

Adjustable seat height
Adjustable back height
Adjustable seat and back angle
Adjustable weight tension

Fixed arms
3 lever ergonomic mechanism
600mm black nylon 5 star base

Available in black only
Suitable for indoor use only



RIO RANGE

INSTRUCTION OF USE

To adjust back height hold back with two hands while seated and raise to desired height

To lower the back height raise back all the way to the top and release slowly

RIGHT BACK LEVER
To adjust back angle

RIGHT FRONT LEVER
To adjust seat height

600MM BLACK NYLON 5 STAR BASE WITH CASTORS

Use soft tyred castors for tiles
Use hard tyred castors for carpet

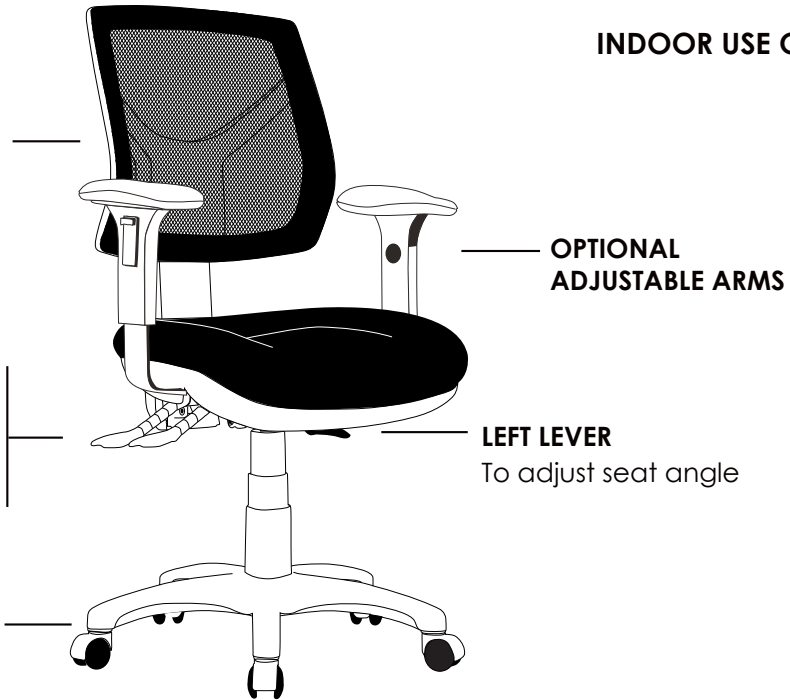

INDOOR USE ONLY

X Do not use as a step ladder

DIMENSIONS: (mm)

LOW BACK **LOW BACK TO FLOOR**
W: 430 Lowest: 925
H: 450 Highest: 1120

HIGH BACK **HIGH BACK TO FLOOR**
W: 455 Lowest: 1010
H: 530 Highest: 1210

SEAT **SEAT TO FLOOR**
W: 500 Lowest: 485
D: 460 Highest: 625

ARM TO FLOOR
Lowest: 630
Highest: 840



RIO-H



RIO-HC



RIO-L

RIO-LC

Features:

Adjustable seat height
 Adjustable back height (ratchet)
 Adjustable seat and back angle
 Moulded seat foam
 Java seat

3 lever ergonomic mechanism
 600mm black nylon 5 star base
 Available in Metro black only
 AFRDI tested to level 6
 Suitable for indoor use only



Optional drafting kit

HINO RANGE

INSTRUCTION OF USE

To adjust back height hold back with two hands while seated and raise to desired height

To lower the back height raise back all the way to the top and release slowly

RIGHT BACK LEVER
To adjust back angle

RIGHT MIDDLE LEVER
To adjust seat angle

RIGHT FRONT LEVER
To adjust seat height

700MM BLACK NYLON 5 STAR BASE WITH CASTORS

Use soft tyred castors for tiles
Use hard tyred castors for carpet



INDOOR USE ONLY

**OPTIONAL
ADJUSTABLE ARMS**

FRONT KNOB
To adjust weight tension

X Do not use as a step ladder

DIMENSIONS: (mm)

BACK

W: 450

H: 530

BACK TO FLOOR

Lowest: 1025

Highest: 1150

SEAT

W: 560

D: 510

SEAT TO FLOOR

Lowest: 520

Highest: 600

ARM TO FLOOR

Lowest: 665

Highest: 830



HINO



HINO-C



Back view

Features:

Adjustable seat height
Adjustable back height (ratchet)
Adjustable seat and back angle
Adjustable weight tension

Moulded seat foam
Mega big boy seat
3 lever heavy duty ergonomic mechanism
700mm black nylon 5 star base

Available in Metro black only
AFRDI tested to level 6
Suitable for indoor use only



FUSE RANGE

INSTRUCTION OF USE

To adjust back height hold back with two hands while seated and raise to desired height

To lower the back height raise back all the way to the top and release slowly

RIGHT BACK LEVER
To adjust back angle

RIGHT MIDDLE LEVER
To adjust seat angle

RIGHT FRONT LEVER
To adjust seat height

700MM BLACK NYLON 5 STAR BASE WITH CASTORS

Use soft tyred castors for tiles
Use hard tyred castors for carpet

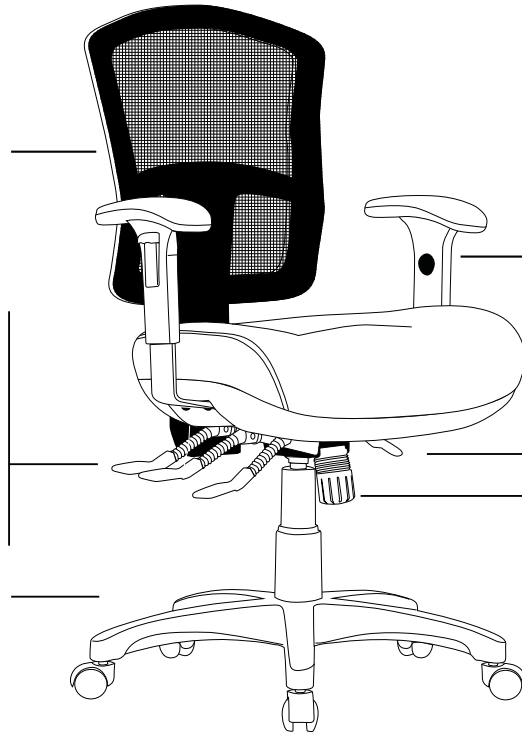

INDOOR USE ONLY

**OPTIONAL
ADJUSTABLE ARMS**

LEFT LEVER
To adjust seat depth
(Build-in seat slider)

FRONT KNOB
To adjust weight tension

X Do not use as a step ladder

DIMENSIONS: (mm)

BACK

W: 490

H: 465

BACK TO FLOOR

Lowest: 1070

Highest: 1225

SEAT

W: 530

D: 465

SEAT TO FLOOR

Lowest: 535

Highest: 615

ARM TO FLOOR

Lowest: 685

Highest: 830



FUSE



FUSE-C



Back view

Features:

Adjustable seat height
Adjustable back height (ratchet)
Adjustable back and seat angle
Adjustable weight tension

Adjustable seat depth (build-in seat slider)
Moulded seat foam
Big boy seat
3 lever ergonomic heavy duty mechanism

700mm black nylon 5 star base
Available in Metro black only
AFRDI tested to level 6
Suitable for indoor use only



BRENT RANGE

INSTRUCTION OF USE

To adjust back height hold back with two hands while seated and raise to desired height

To lower the back height raise back all the way to the top and release slowly

RIGHT BACK LEVER
To adjust back angle

RIGHT MIDDLE LEVER
To adjust seat angle

RIGHT FRONT LEVER
To adjust seat height

700MM BLACK NYLON 5 STAR BASE WITH CASTORS

Use soft tyred castors for tiles
Use hard tyred castors for carpet

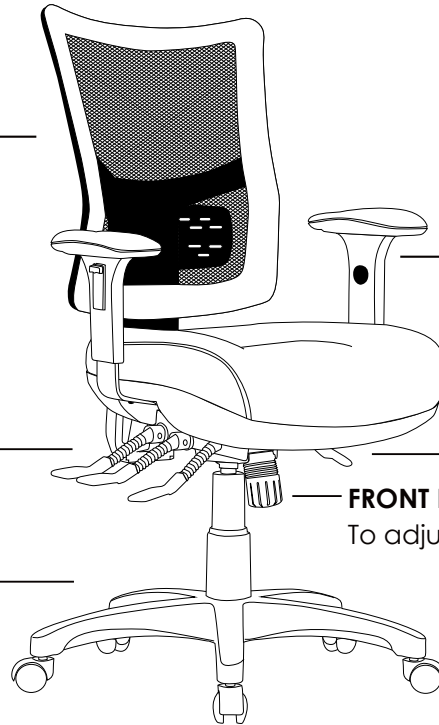

INDOOR USE ONLY

OPTIONAL ADJUSTABLE ARMS

LEFT LEVER
To adjust seat depth
(Build-in seat slider)

FRONT KNOB
To adjust weight tension

X Do not use as a step ladder

DIMENSIONS: (mm)

BACK

W: 490

H: 525

BACK TO FLOOR

Lowest: 1055

Highest: 1210

SEAT

W: 530

D: 465

SEAT TO FLOOR

Lowest: 535

Highest: 615

ARM TO FLOOR

Lowest: 685

Highest: 830



BRENT



BRENT-C



Back view

Features:

- Adjustable seat height
- Adjustable back height (ratchet)
- Adjustable back and seat angle
- Adjustable weight tension
- Adjustable seat depth (build-in seat slider)

- Adjustable lumbar support
- Moulded seat foam
- Big boy seat
- 3 lever ergonomic heavy duty mechanism

- 700mm black nylon 5 star base
- Available in Metro black only
- AFRDI tested to level 6
- Suitable for indoor use only



P350 RANGE

INSTRUCTION OF USE

INDOOR USE ONLY

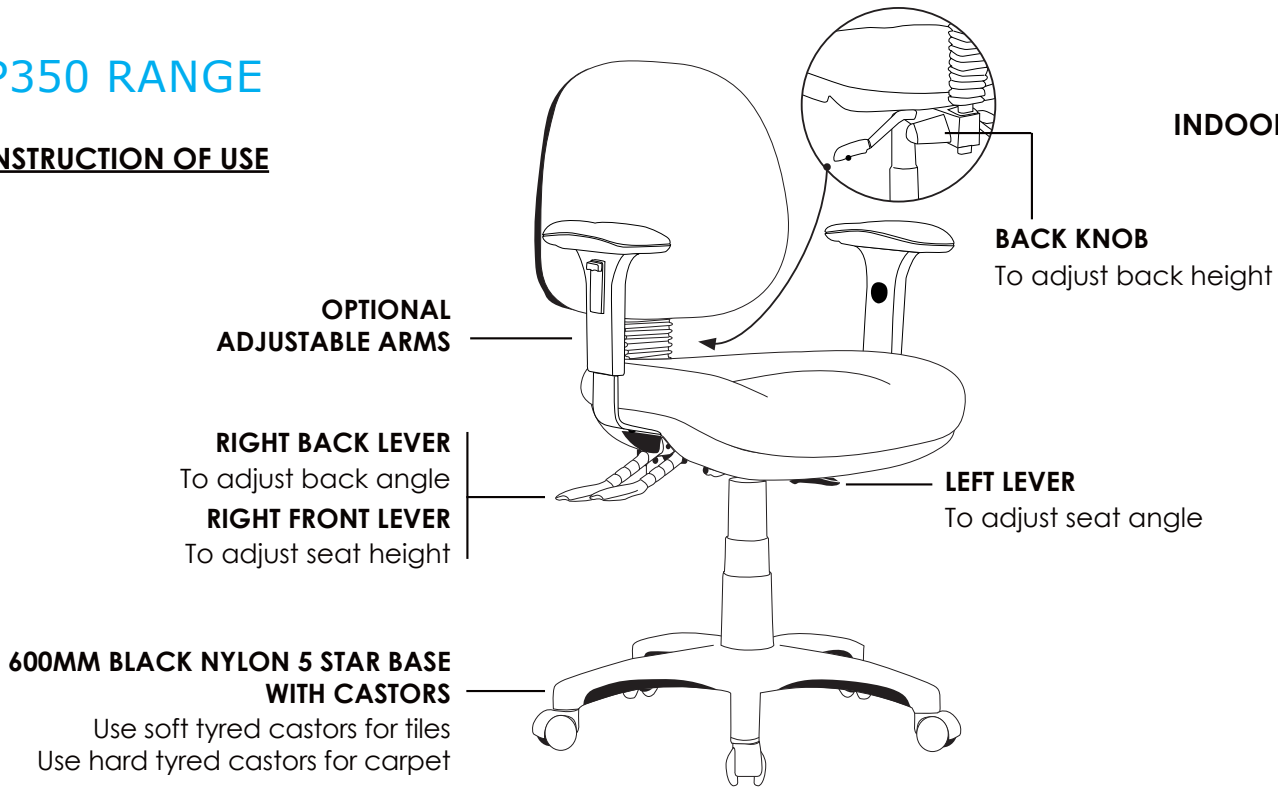

X Do not use as a step ladder

DIMENSIONS: (mm)

LOW BACK LOW BACK TO FLOOR

W: 440 Lowest: 860
H: 400 Highest: 1045

HIGH BACK HIGH BACK TO FLOOR

W: 450 Lowest: 950
H: 510 Highest: 1150

SEAT

W: 500
D: 460

SEAT TO FLOOR

Lowest: 480
Highest: 625

ARM TO FLOOR

Lowest: 630
Highest: 840



P350H-MB



P350HC-MB



P350-MB

P350C-MB

Features:

Adjustable seat height
 Adjustable back height
 Adjustable seat and back angle
 Moulded seat and back foam
 Java seat

3 lever ergonomic mechanism
 600mm black nylon 5 star base
 Available in Metro black only
 AFRDI tested to level 6
 Suitable for indoor use only



Optional drafting kit

AQUA RANGE

INSTRUCTION OF USE

To adjust back height hold back with two hands while seated and raise to desired height

To lower the back height raise back all the way to the top and release slowly

RIGHT BACK LEVER
To adjust back angle

RIGHT FRONT LEVER
To adjust seat height

600MM BLACK NYLON 5 STAR BASE WITH CASTORS

Use soft tyred castors for tiles
Use hard tyred castors for carpet

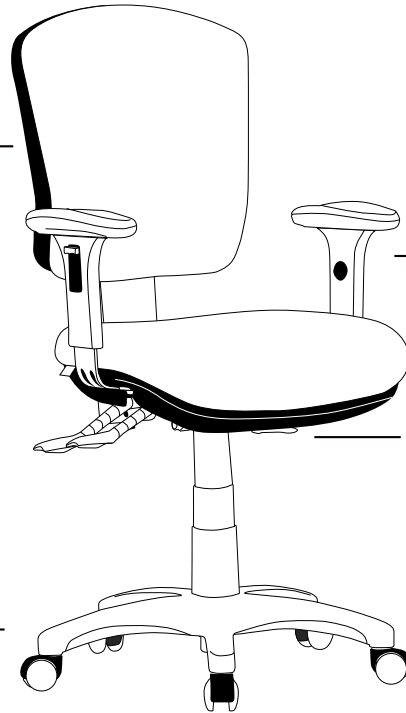

INDOOR USE ONLY

**OPTIONAL
ADJUSTABLE ARMS**

LEFT LEVER
To adjust seat angle

X Do not use as a step ladder

DIMENSIONS: (mm)

LOW BACK LOW BACK TO FLOOR

W: 460 Lowest: 850
H: 440 Highest: 1060

HIGH BACK HIGH BACK TO FLOOR

W: 470 Lowest: 950
H: 540 Highest: 1170

SEAT

W: 500
D: 460

SEAT TO FLOOR

Lowest: 485
Highest: 625

ARM TO FLOOR

Lowest: 630
Highest: 840



AQUA-H



AQUA-HC

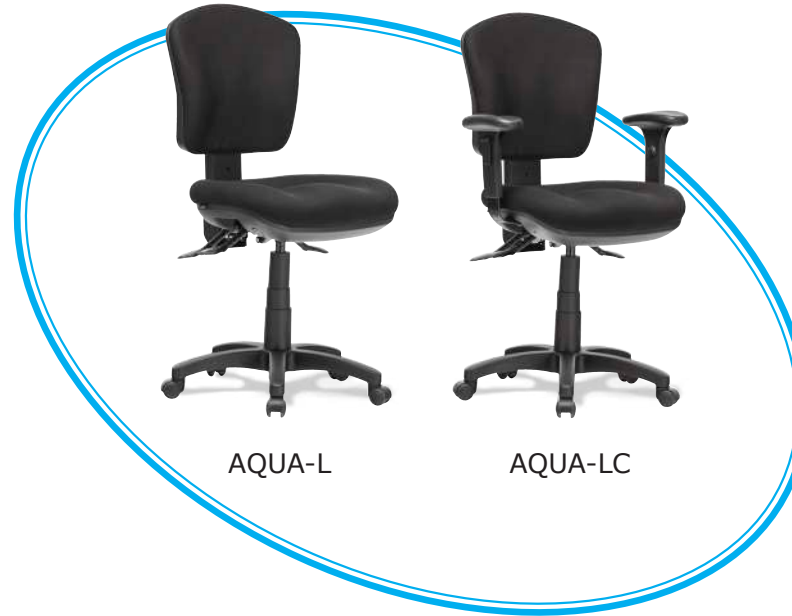

AQUA-L

AQUA-LC

Features:

Adjustable seat height
Adjustable back height (ratchet)
Adjustable seat and back angle
Moulded seat and back foam
Java seat

3 lever ergonomic mechanism
600mm black nylon 5 star base
Available in Metro black only
AFRDI tested to level 6
Suitable for indoor use only



Optional drafting kit

TR600 RANGE

INSTRUCTION OF USE

To adjust back height hold back with two hands while seated and raise to desired height

To lower the back height raise back all the way to the top and release slowly

RIGHT BACK LEVER

To adjust back angle

RIGHT MIDDLE LEVER

To adjust seat angle

RIGHT FRONT LEVER

To adjust seat height

700MM BLACK NYLON 5 STAR BASE WITH CASTORS

Use soft tyred castors for tiles
Use hard tyred castors for carpet



INDOOR USE ONLY

**OPTIONAL
ADJUSTABLE ARMS**

FRONT KNOB
To adjust weight tension

X Do not use as a step ladder

DIMENSIONS: (mm)

BACK

W: 490

H: 580

BACK TO FLOOR

Lowest: 1080

Highest: 1240

SEAT

W: 560

D: 510

SEAT TO FLOOR

Lowest: 520

Highest: 600

ARM TO FLOOR

Lowest: 665

Highest: 830



TR600



TR600-C



Back view

Features:

Adjustable seat height
Adjustable back height (ratchet)
Adjustable seat and back angle
Adjustable weight tension

Moulded seat and back foam
Mega big boy seat
3 lever heavy duty ergonomic mechanism
700mm black nylon 5 star base

Available in Metro black only
AFRDI tested to level 6
Suitable for indoor use only



SPOT RANGE

INSTRUCTION OF USE

To adjust back height hold back with two hands while seated and raise to desired height

To lower the back height raise back all the way to the top and release slowly

RIGHT BACK LEVER
To adjust back angle

RIGHT MIDDLE LEVER
To adjust seat angle

RIGHT FRONT LEVER
To adjust seat height

700MM BLACK NYLON 5 STAR BASE WITH CASTORS

Use soft tyred castors for tiles
Use hard tyred castors for carpet



INDOOR USE ONLY

X Do not use as a step ladder

DIMENSIONS: (mm)

BACK

W: 460

H: 560

BACK TO FLOOR

Lowest: 1025

Highest: 1165

SEAT

W: 560

D: 510

SEAT TO FLOOR

Lowest: 520

Highest: 600

ARM TO FLOOR

Lowest: 665

Highest: 830



SPOT



SPOT-C



Back view

Features:

Adjustable seat height
Adjustable back height (ratchet)
Adjustable seat and back angle
Adjustable weight tension

Moulded seat and back foam
Mega big boy seat
3 lever heavy duty ergonomic mechanism
700mm black nylon 5 star base

Available in Metro black only
AFRDI tested to level 6
Suitable for indoor use only



NEWTON RANGE

INSTRUCTION OF USE

To adjust back height hold back with two hands while seated and raise to desired height
To lower the back height raise back all the way to the top and release slowly

RIGHT BACK LEVER
To adjust back angle
RIGHT MIDDLE LEVER
To adjust seat angle
RIGHT FRONT LEVER
To adjust seat height

700MM BLACK NYLON 5 STAR BASE WITH CASTORS
Use soft tyred castors for tiles
Use hard tyred castors for carpet

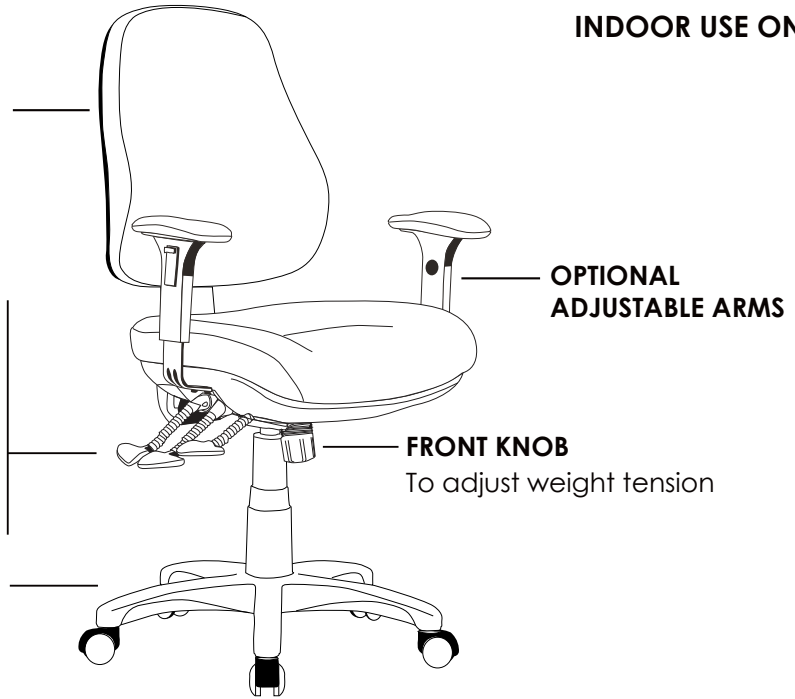

INDOOR USE ONLY

X Do not use as a step ladder

DIMENSIONS: (mm)

BACK	BACK TO FLOOR	SEAT	SEAT TO FLOOR	ARM TO FLOOR
W: 500	Lowest: 1045	W: 560	Lowest: 520	Lowest: 665
H: 550	Highest: 1200	D: 510	Highest: 600	Highest: 830



NEWTON



NEWTON-C



Back view

Features:

Adjustable seat height
Adjustable back height (ratchet)
Adjustable seat and back angle
Adjustable weight tension

Moulded seat and back foam
Mega big boy seat
3 lever heavy duty ergonomic mechanism
700mm black nylon 5 star base

Available in Metro black only
AFRDI tested to level 6
Suitable for indoor use only

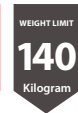

TRENT RANGE

INSTRUCTION OF USE

INDOOR USE ONLY

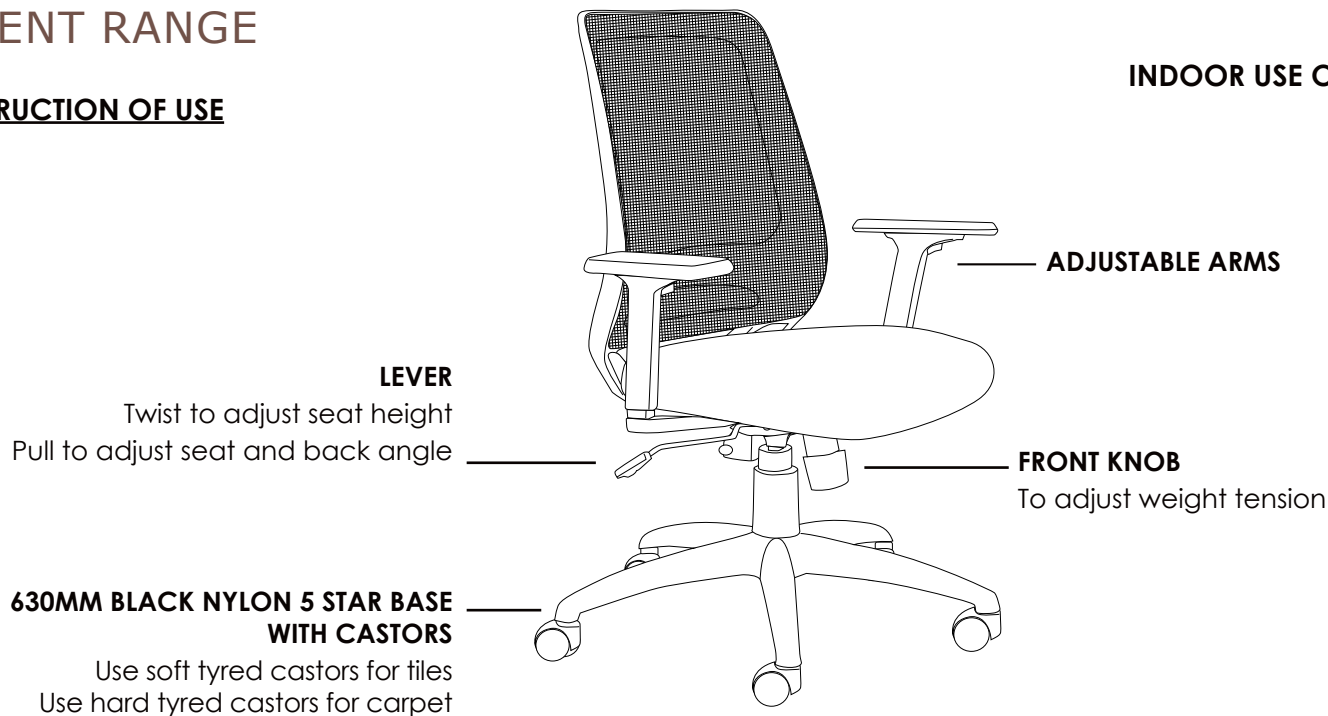

X Do not use as a step ladder

DIMENSIONS: (mm)

BACK

W: 475

H: 500

BACK TO FLOOR

Lowest: 940

Highest: 1035

SEAT

W: 500

D: 490

SEAT TO FLOOR

Lowest: 460

Highest: 555

ARM TO FLOOR

Lowest: 635

Highest: 795



TRENT



Side view



Back view



Features:

Adjustable seat height
Adjustable seat and back angle
Adjustable weight tension

Adjustable arms
Butterfly mechanism
630mm black nylon 5 star base

Available in black only
Suitable for indoor use only

DELA RANGE

INSTRUCTION OF USE

INDOOR USE ONLY



RIGHT LEVER
To adjust seat height

LEFT LEVER
To adjust seat and back angle

FRONT KNOB
To adjust weight tension

620MM BLACK NYLON 5 STAR BASE WITH CASTORS
Use soft tyred castors for tiles
Use hard tyred castors for carpet

X Do not use as a step ladder

DIMENSIONS: (mm)

BACK	BACK TO FLOOR	SEAT	SEAT TO FLOOR	ARM TO FLOOR
W: 485	Lowest: 990	W: 510	Lowest: 450	Lowest: 660
H: 570	Highest: 1090	D: 480	Highest: 550	Highest: 760



DELA



Side view



Back view



Features:

Adjustable seat height
Adjustable seat and back angle
Adjustable weight tension

Lumbar support
Knee tilt mechanism with 3 locking positions
620mm black nylon 5 star base

Available in black only
Suitable for indoor use only

GALA RANGE

INSTRUCTION OF USE

INDOOR USE ONLY

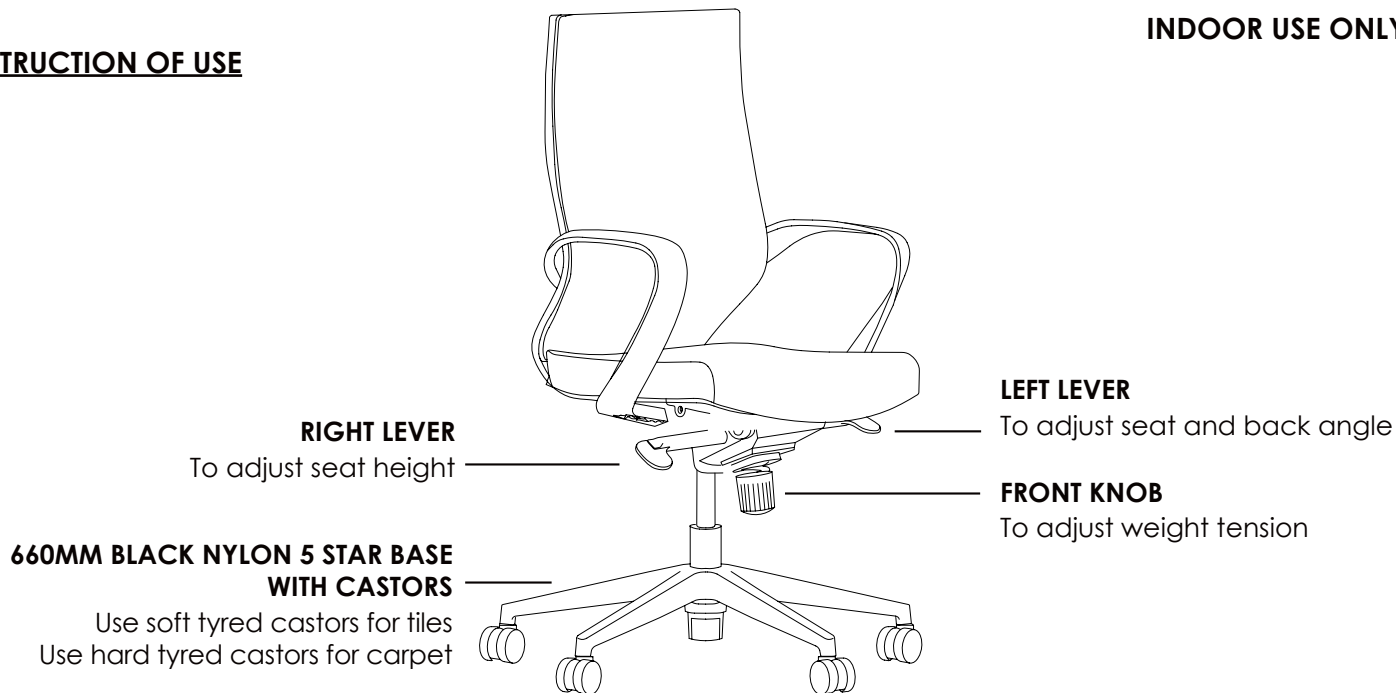

X Do not use as a step ladder

DIMENSIONS: (mm)

BACK

W: 500

H: 510

BACK TO FLOOR

Lowest: 960

Highest: 1030

SEAT

W: 505

D: 480

SEAT TO FLOOR

Lowest: 460

Highest: 530

ARM TO FLOOR

Lowest: 680

Highest: 750



GALA



Side view



Back view

Features:

Adjustable seat height
Adjustable seat and back angle
Adjustable weight tension

Knee tilt mechanism with 3 locking positions
660mm black nylon 5 star base

Available in black only
Suitable for indoor use only



WEB RANGE

INSTRUCTION OF USE

INDOOR USE ONLY



RIGHT LEVER

To adjust seat height

LEFT LEVER

To adjust seat and back angle

FRONT KNOB

To adjust weight tension

700MM ALUMINIUM 5 STAR BASE WITH CASTORS

Use soft tyred castors for tiles
Use hard tyred castors for carpet

X Do not use as a step ladder

DIMENSIONS: (mm)

BACK

W: 445

H: 460

BACK TO FLOOR

Lowest: 940

Highest: 1000

SEAT

W: 510

D: 440

SEAT TO FLOOR

Lowest: 475

Highest: 535

ARM TO FLOOR

Lowest: 695

Highest: 755



WEB-LB



Side view



Back view

Features:

Adjustable seat height
Adjustable seat and back angle
Adjustable weight tension

Knee tilt mechanism with 3 locking positions
700mm aluminium 5 star base

Available in black PU only
Suitable for indoor use only



VOLT RANGE

INSTRUCTION OF USE

INDOOR USE ONLY

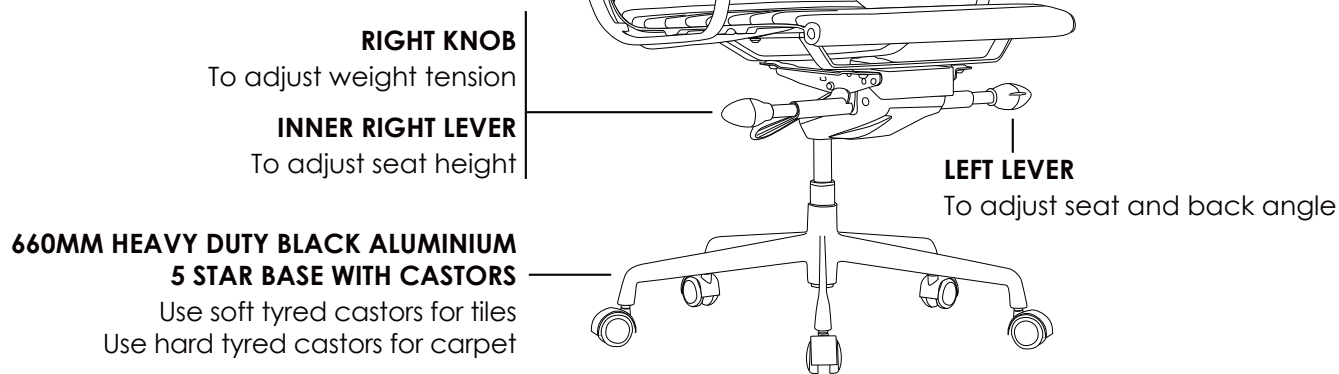

X Do not use as a step ladder

DIMENSIONS: (mm)

BACK

W: 530

H: 480

BACK TO FLOOR

Lowest: 940

Highest: 990

SEAT

W: 500

D: 450

SEAT TO FLOOR

Lowest: 460

Highest: 510

ARM TO FLOOR

Lowest: 690

Highest: 740



VOLT-TE



VOLT-TA



VOLT-BL

WARRANTY 5 Year	WEIGHT LIMIT 130 Kilogram	IMPORTED
-------------------------------------	---	---------------------

Features:

Adjustable seat height
Adjustable seat and back angle
Adjustable weight tension
Black powder coated frame

Knee tilt mechanism with 3 locking positions
660mm heavy duty black aluminium base
Available in terracotta, tan and black PU only
Suitable for indoor use only

COLOUR



TE-
TERRACOTTA



TA-TAN



BL-BLACK

ROVER RANGE

INSTRUCTION OF USE

To adjust back height hold back with two hands while seated and raise to desired height

To lower the back height raise back all the way to the top and release slowly

RIGHT FOURTH LEVER
To adjust back angle

RIGHT THIRD LEVER
To adjust seat angle

RIGHT SECOND LEVER
To adjust seat height

RIGHT FRONT LEVER
To adjust seat front angle

**700MM BLACK NYLON
5 STAR BASE WITH CASTORS**

Use soft tyred castors for tiles
Use hard tyred castors for carpet

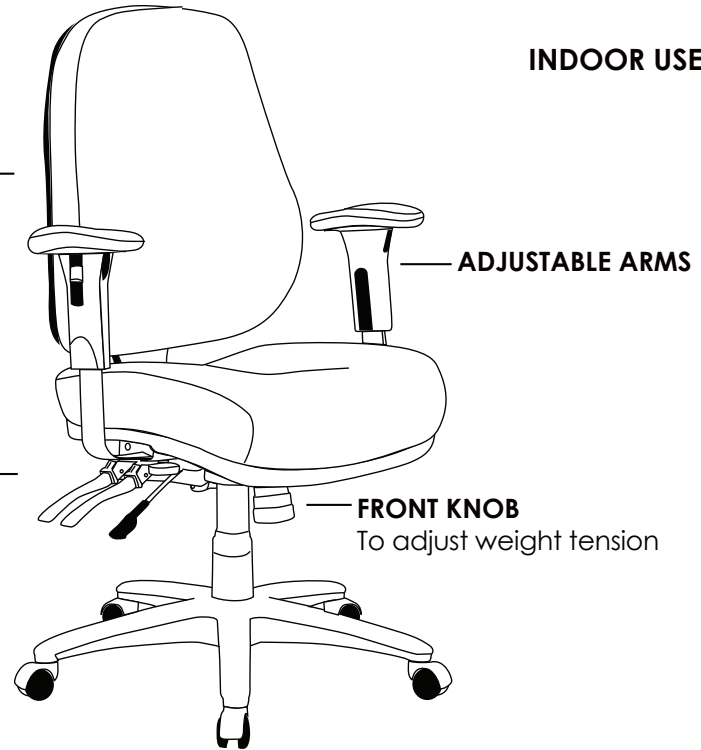

INDOOR USE ONLY

X Do not use as a step ladder

DIMENSIONS: (mm)

BACK

W: 500

H: 630

BACK TO FLOOR

Lowest: 1095

Highest: 1260

SEAT

W: 510

D: 520

SEAT TO FLOOR

Lowest: 480

Highest: 570

ARM TO FLOOR

Lowest: 640

Highest: 790



ROVER-1HA



Side view



Back view

Features:

Adjustable seat height
Adjustable back height (ratchet)
Adjustable seat and back angle
Adjustable weight tension

Adjustable arms
Moulded seat and back foam
4 lever ergonomic mechanism

700mm black nylon 5 star base
Available in black leather only
Suitable for indoor use only



OYSTER RANGE

INSTRUCTION OF USE

To adjust back height hold back with two hands while seated and raise to desired height

To lower the back height raise back all the way to the top and release slowly (LOW BACK ONLY)

RIGHT BACK KNOB

To adjust seat depth (seat slider)

RIGHT BACK LEVER

To adjust back angle

RIGHT MIDDLE LEVER

To adjust seat angle

RIGHT FRONT LEVER

To adjust seat height

700MM ALUMINIUM 5 STAR BASE WITH CASTORS

Use soft tyred castors for tiles
Use hard tyred castors for carpet

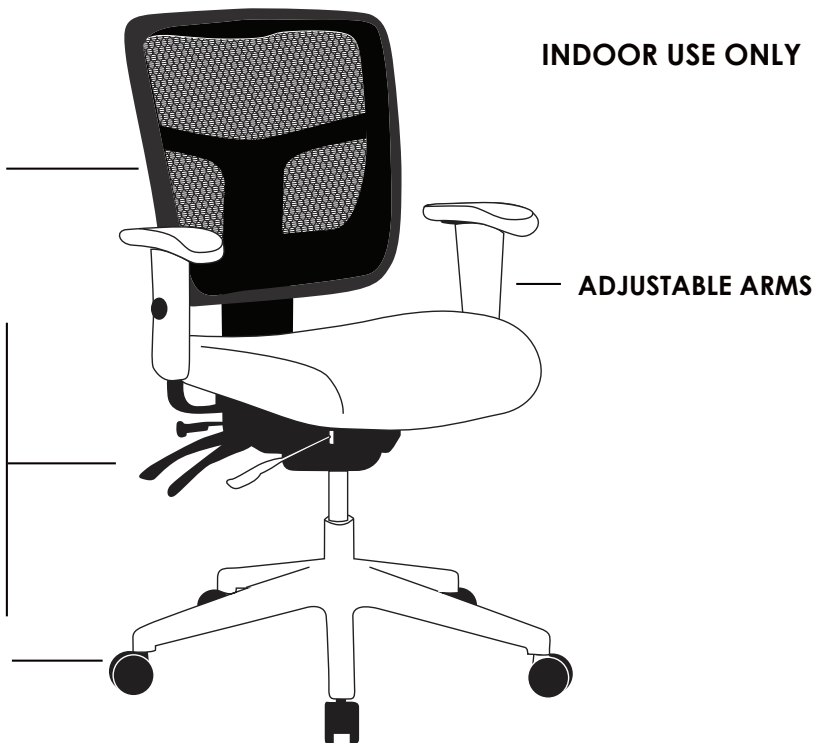

X Do not use as a step ladder

DIMENSIONS: (mm)

LOW BACK	BACK TO FLOOR	MEDIUM BACK	BACK TO FLOOR	HEADREST	HIGH BACK TO FLOOR	SEAT	SEAT TO FLOOR	ARM TO FLOOR
W: 500	Lowest: 910	W: 500	Lowest: 1040	W: 345	Lowest: 1180	W: 500	Lowest: 480	Lowest: 660
H: 500	Highest: 1045	H: 660	Highest: 1130	H: 170	Highest: 1360	D: 470	Highest: 570	Highest: 810

* Please note that the Headrest should not be used to manoeuvre the chair.



OYEX1-H



OYEX1-M



OYEX1-L

Features:

Adjustable seat height
Adjustable back height (ratchet)
(Available in low back only)
Adjustable seat and back angle

Adjustable seat depth (seat slider)
Adjustable arms
Moulded seat foam
4 lever ergonomic mechanism

700mm aluminium 5 star base
Available in black only
Suitable for indoor use only



RANGER RANGE

INSTRUCTION OF USE

INDOOR USE ONLY

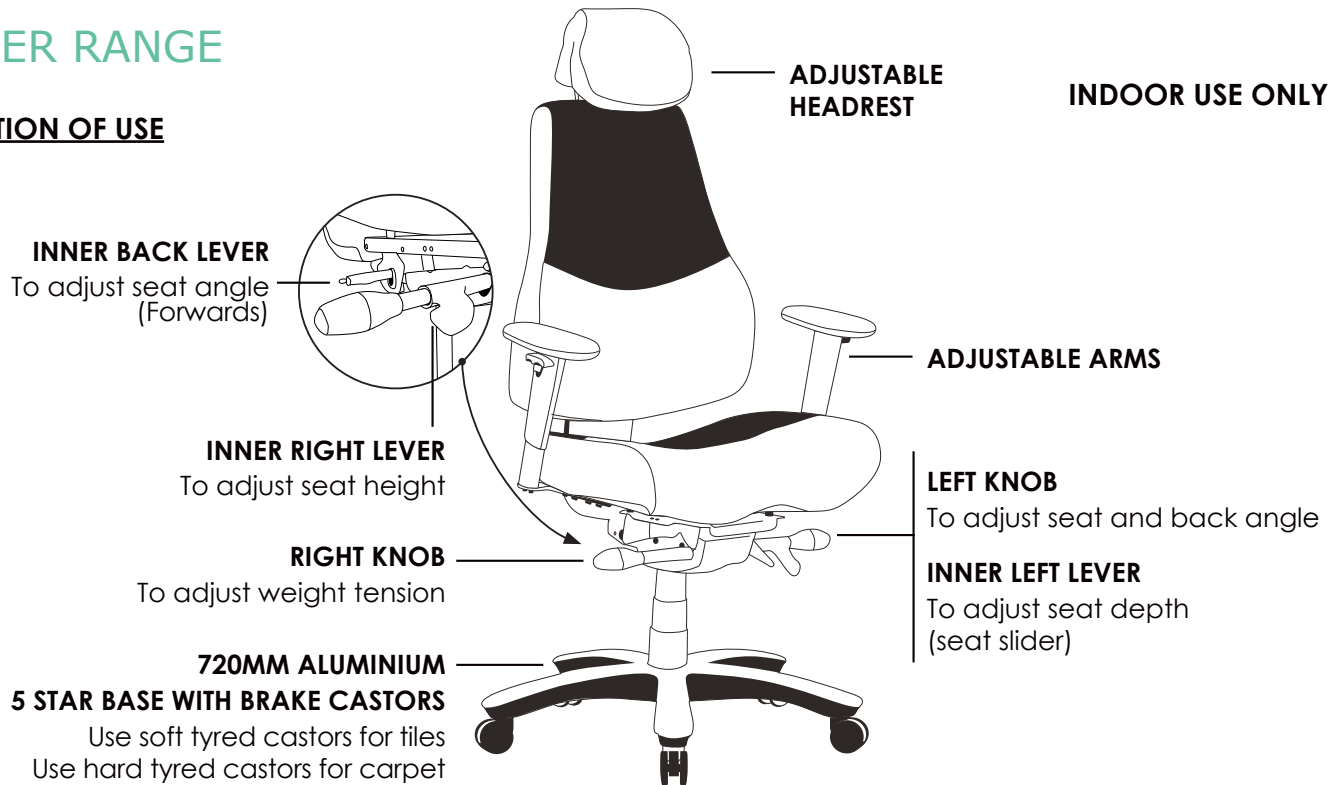

X Do not use as a step ladder

DIMENSIONS: (mm)

BACK WITH HEADREST

W: 475

H: 720

HEADREST TO FLOOR

Lowest: 1230

Highest: 1350

SEAT

W: 515

D: 540

SEAT TO FLOOR

Lowest: 525

Highest: 645

ARM TO FLOOR

Lowest: 700

Highest: 920

* Please note that the Headrest should not be used to manoeuvre the chair.



RANGER



Side view



Back view

Features:

Adjustable seat height
Adjustable seat and back angle
Forward seat tilt adjustment
Adjustable seat depth (seat slider)
Adjustable weight tension
Adjustable arms

Adjustable headrest
Moulded seat and back foam
Saddle seat
Synchron mechanism with 3 locking positions
720mm aluminium 5 star base

Brake castors
Available in black and grey only
AFRDI tested to level 6
AFRDI tested to multi shift use 160kg
Suitable for indoor use only



IMPACT RANGE

INDOOR USE ONLY

INSTRUCTION OF USE

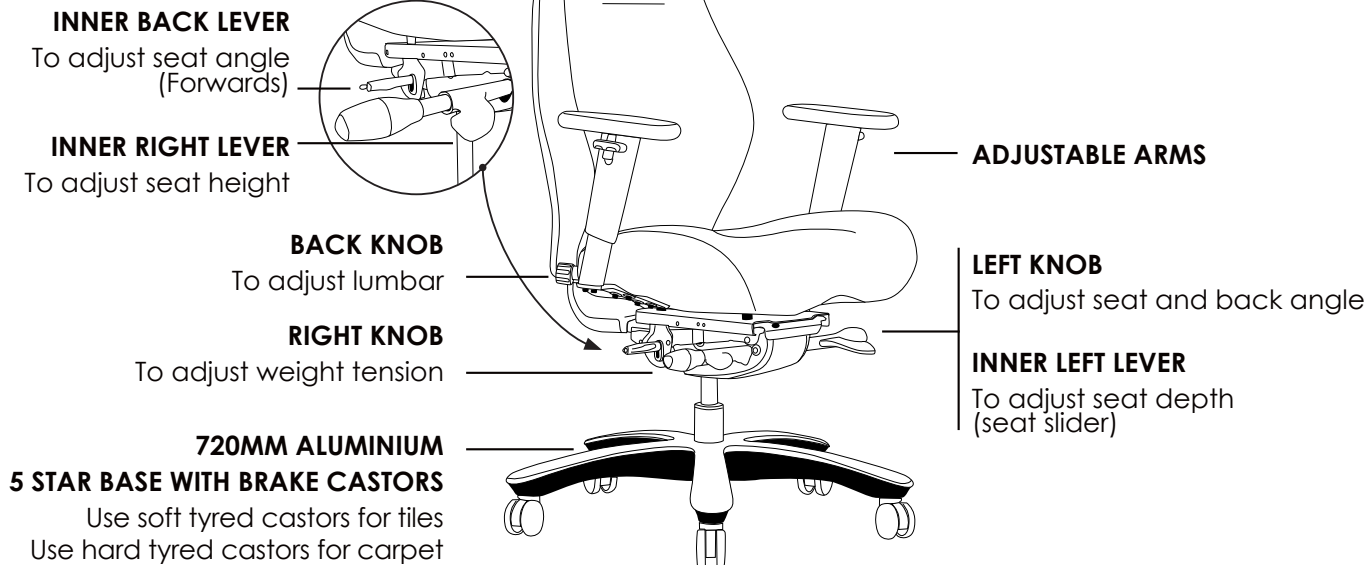

X Do not use as a step ladder

DIMENSIONS: (mm)

BACK **BACK TO FLOOR**
W: 475 Lowest: 1060
H: 615 Highest: 1180

HEADREST **HEADREST TO FLOOR**
W: 260 Lowest: 1240
H: 180 Highest: 1360

SEAT **SEAT TO FLOOR**
W: 540 Lowest: 505
D: 490 Highest: 625

ARM TO FLOOR
Lowest: 675
Highest: 875

* Please note that the Headrest should not be used to manoeuvre the chair.



IMPACT-H



IMPACT-L



Back view

Features:

Adjustable seat height
Adjustable seat and back angle
Forward seat tilt adjustment
Adjustable seat depth (seat slider)
Adjustable weight tension

Adjustable lumbar support
Adjustable arms
Moulded seat and back foam
Saddle seat
Synchron mechanism with 3 locking positions

720mm aluminium 5 star base
Brake castors
Available in black fabric only
AFRDI tested to level 6
Suitable for indoor use only



RAPTOR RANGE

INSTRUCTION OF USE

INDOOR USE ONLY

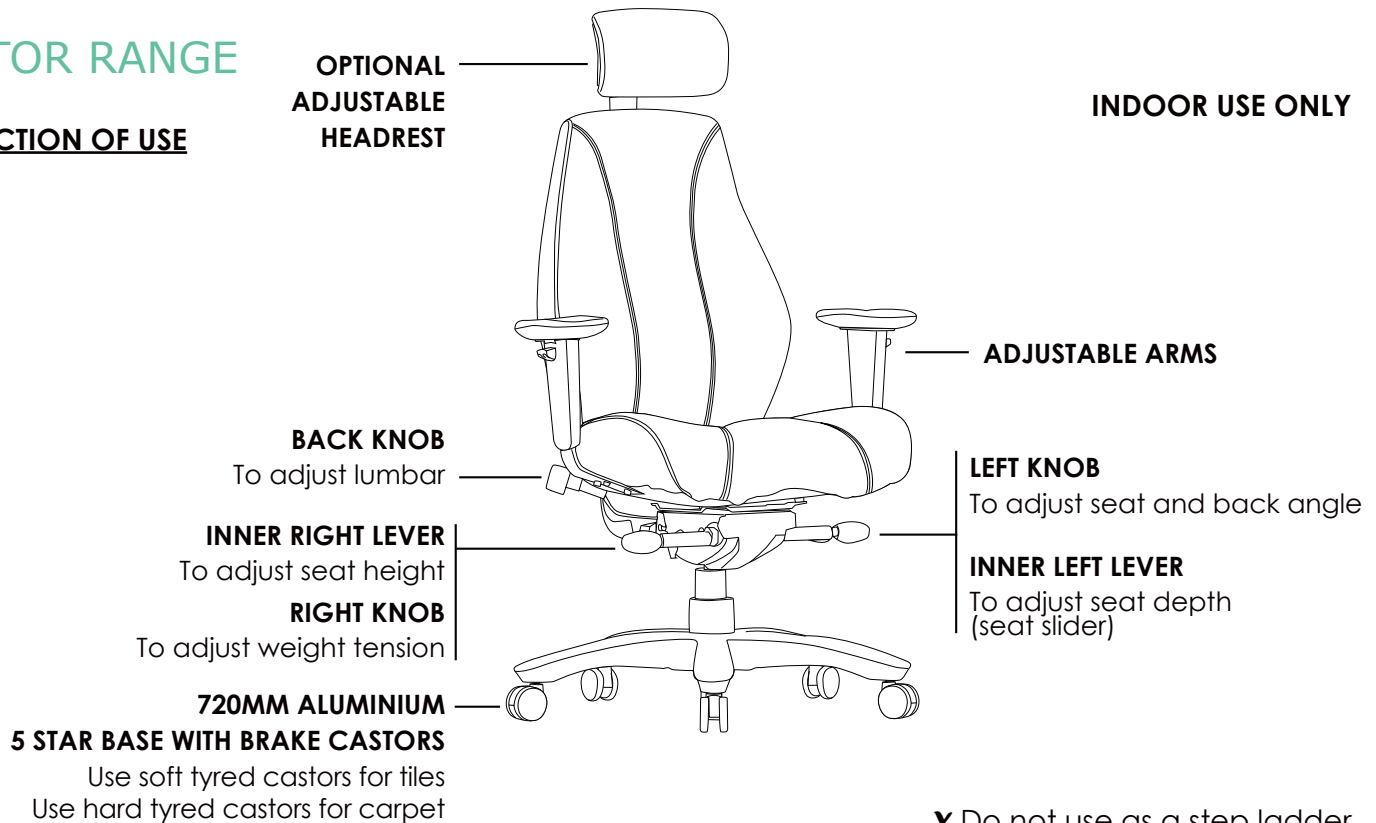

DIMENSIONS: (mm)

BACK **BACK TO FLOOR**
W: 475 Lowest: 1060
H: 615 Highest: 1160

HEADREST **HEADREST TO FLOOR**
W: 265 Lowest: 1195
H: 170 Highest: 1340

SEAT **SEAT TO FLOOR**
W: 540 Lowest: 500
D: 490 Highest: 600

ARM TO FLOOR
Lowest: 680
Highest: 860

* Please note that the Headrest should not be used to manoeuvre the chair.



RAPTOR-H



RAPTOR-L



Back view

Features:

Adjustable seat height
Adjustable seat and back angle
Adjustable seat depth (seat slider)
Adjustable weight tension
Adjustable lumbar support

Adjustable headrest
Adjustable arms
Moulded seat and back foam
Saddle seat
Synchron mechanism with 3 locking positions

720mm aluminum 5 star base
Brake castors
Available in black leather only
AFRDI tested to level 6
Suitable for indoor use only



CORSA RANGE

INSTRUCTION OF USE

INDOOR USE ONLY

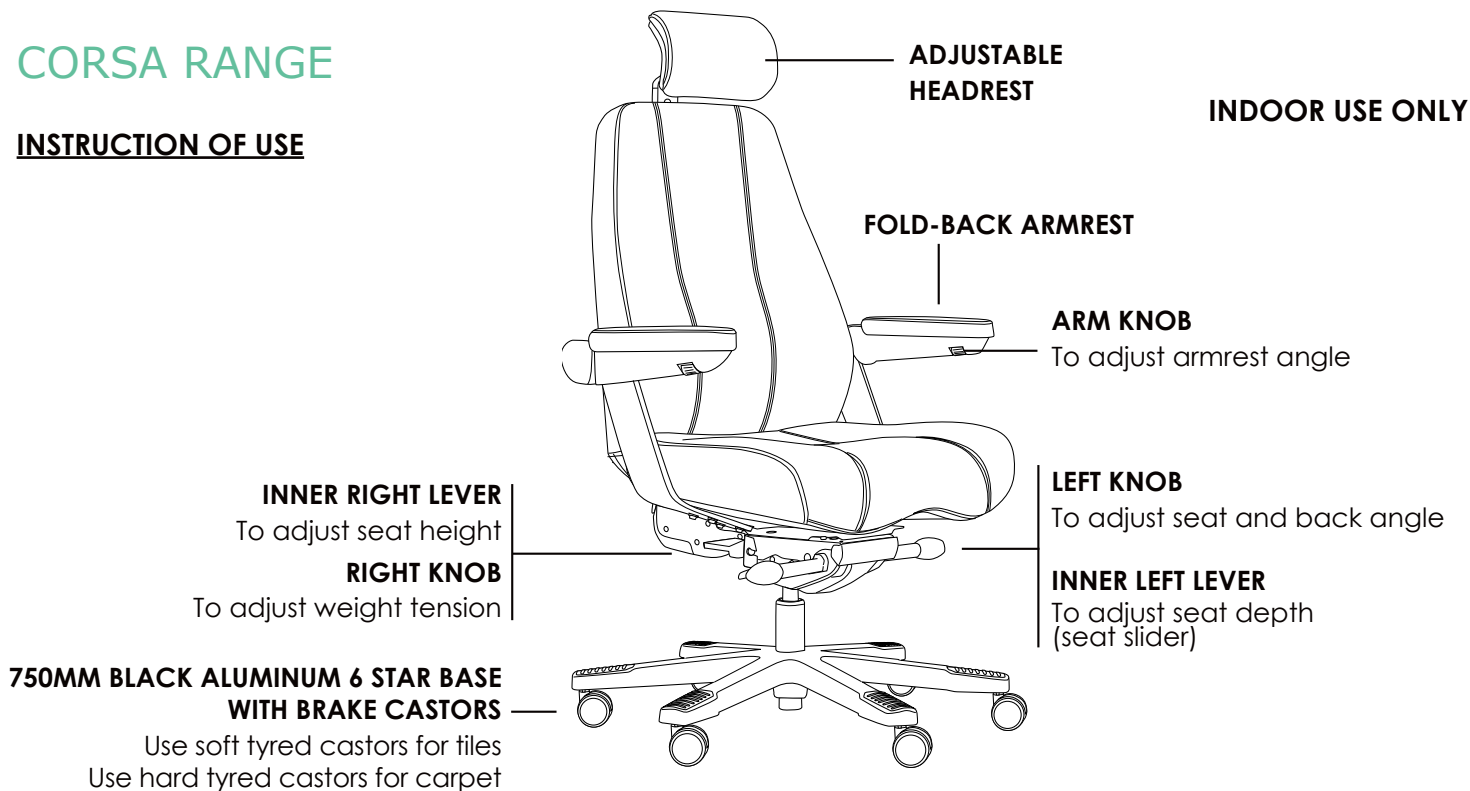

DIMENSIONS: (mm)

BACK **BACK TO FLOOR**
W: 540 Lowest: 1110
H: 695 Highest: 1200

HEADREST **HEADREST TO FLOOR**
W: 270 Lowest: 1290
H: 165 Highest: 1380

SEAT **SEAT TO FLOOR**
W: 535 Lowest: 525
D: 460 Highest: 615

ARM TO FLOOR
Lowest: 730
Highest: 820

* Please note that the Headrest should not be used to manoeuvre the chair.



CORSA



Side view



Back view

Features:

Adjustable seat height
Adjustable seat and back angle
Adjustable seat depth (seat slider)
Adjustable weight tension
Adjustable headrest

Lockable incline, fold-back armrests
Moulded seat and back foam
Saddle seat
Synchron mechanism with 3 locking positions
750mm black aluminum 6 star base



* Style rated multi shift use 200KG

Brake castors
Available in black leather only
Suitable for indoor use only

STANZA RANGE

INSTRUCTION OF USE

INDOOR USE ONLY

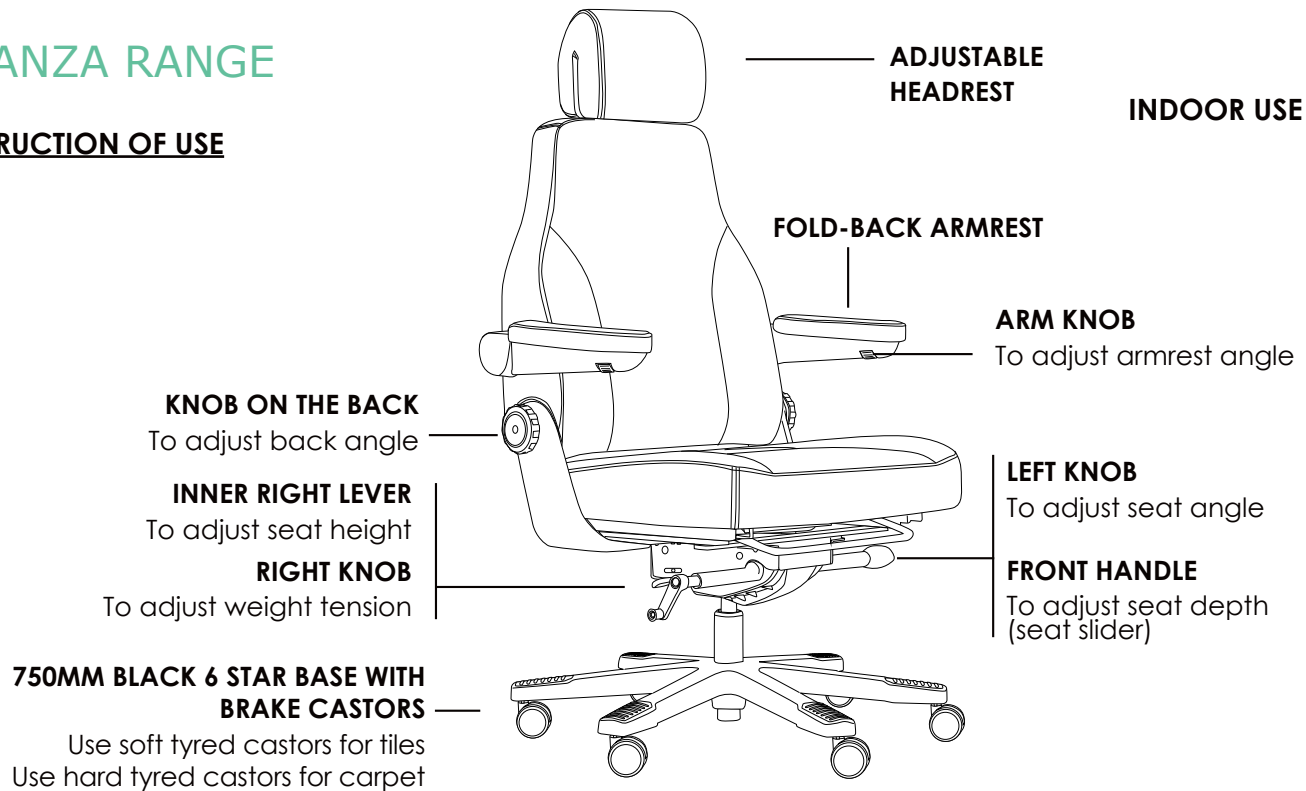

X Do not use as a step ladder

DIMENSIONS: (mm)

BACK **BACK TO FLOOR**
W: 550 Lowest: 1090
H: 590 Highest: 1180

HEADREST **HEADREST TO FLOOR**
W: 260 Lowest: 1275
H: 200 Highest: 1375

SEAT **SEAT TO FLOOR**
W: 610 Lowest: 500
D: 410 Highest: 600

ARM TO FLOOR
Lowest: 735
Highest: 835

* Please note that the Headrest should not be used to manoeuvre the chair.



STANZA



Side view



Back view

Features:

Adjustable seat height
Adjustable seat and back angle
Adjustable seat depth (seat slider)
Adjustable weight tension
Adjustable headrest

Lockable incline, fold-back armrests
Back made of metal construction
Independant back angle adjustment
Moulded seat and back foam
Synchron mechanism with 3 locking positions



* Style rated multi shift use 230KG

750mm black aluminum 6 star base
Brake castors
Available in black automotive leather only
Suitable for indoor use only

GIBBS RANGE

INSTRUCTION OF USE

INDOOR USE ONLY

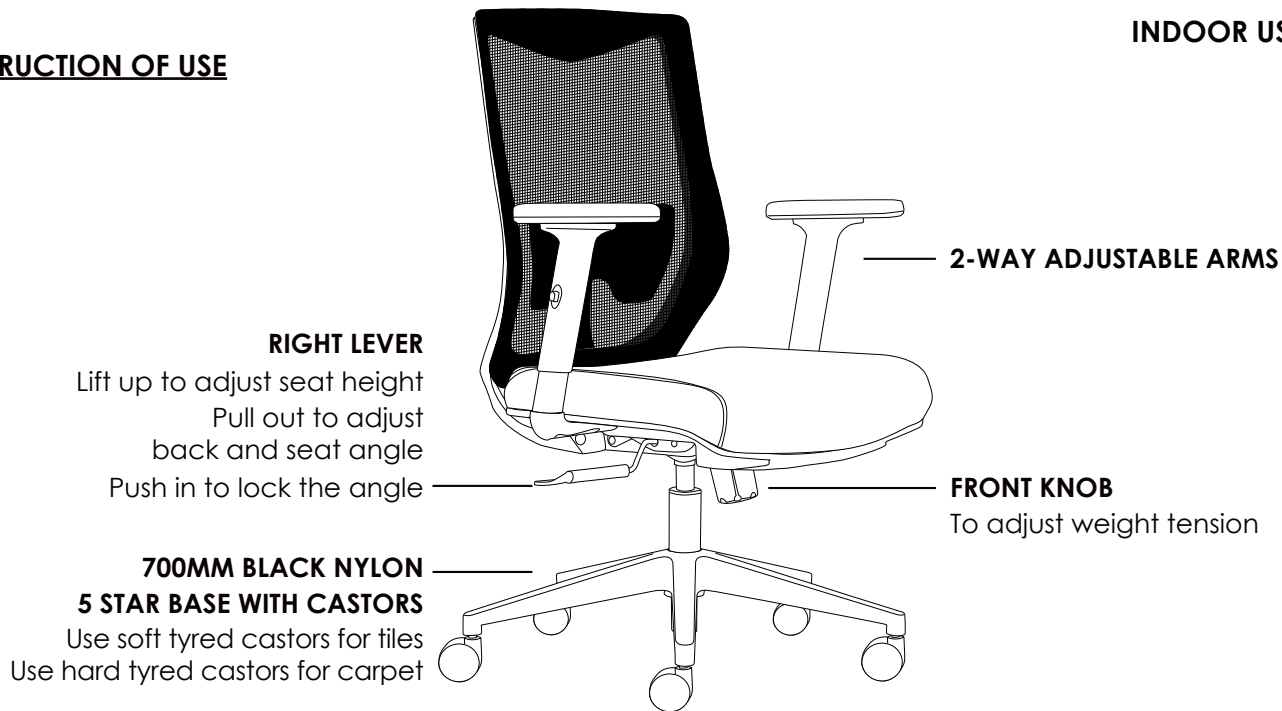

X Do not use as a step ladder

DIMENSIONS: (mm)

BACK

W: 490

H: 560

BACK TO FLOOR

Lowest: 990

Highest: 1090

SEAT

W: 500

D: 510

SEAT TO FLOOR

Lowest: 460

Highest: 560

ARM TO FLOOR

Lowest: 650

Highest: 835



GIBBS



Side view



Back view

Features:

Adjustable seat height
Adjustable seat and back angle
Adjustable weight tension

2-Way adjustable arms
Lumbar support
Butterfly mechanism

700mm black nylon 5 star base
Available in black only
Suitable for indoor use only



DRAFT RANGE

INSTRUCTION OF USE

INDOOR USE ONLY



X Do not use as a step ladder

DIMENSIONS: (mm)

BACK	BACK TO FLOOR	SEAT	SEAT TO FLOOR	ARM TO FLOOR
W: 480	Lowest: 950	W: 500	Lowest: 460	Lowest: 655
H: 520	Highest: 1035	D: 520	Highest: 545	Highest: 810



DRAFT



Side view



Back view

Features:

Adjustable seat height
Adjustable seat and back angle
Adjustable seat depth (seat slider)
Adjustable arms

Adjustable lumbar
Auto weight tensioning
Synchron mechanism with 3 locking positions

640mm black nylon 5 star base
Available in black only
Suitable for indoor use only



BOLT RANGE

INSTRUCTION OF USE

INDOOR USE ONLY

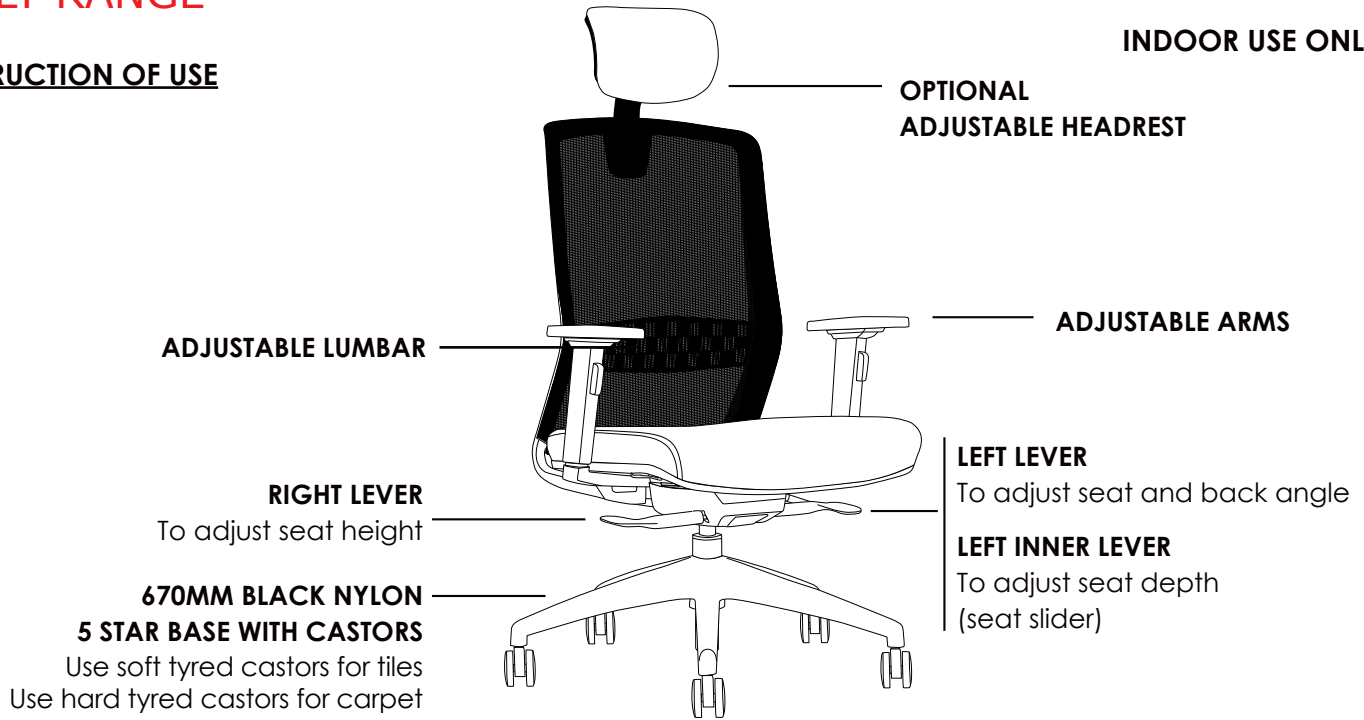

X Do not use as a step ladder

DIMENSIONS: (mm)

BACK **BACK TO FLOOR**
W: 440 Lowest: 940
H: 510 Highest: 1140

HEADREST **HEADREST TO FLOOR**
W: 250 Lowest: 1130
H: 170 Highest: 1260

SEAT **SEAT TO FLOOR**
W: 500 Lowest: 430
D: 495 Highest: 530

ARM TO FLOOR
Lowest: 595
Highest: 750

* Please note that the Headrest should not be used to manoeuvre the chair.



BOLT-H



BOLT-L



Back view

Features:

Adjustable seat height
Adjustable seat and back angle
Adjustable seat depth (seat slider)
Adjustable arms

Adjustable lumbar support
Auto weight tensioning
Synchron mechanism with 3 locking positions

670mm black nylon 5 star base
Available in black only
Suitable for indoor use only



MIAMI RANGE

INSTRUCTION OF USE

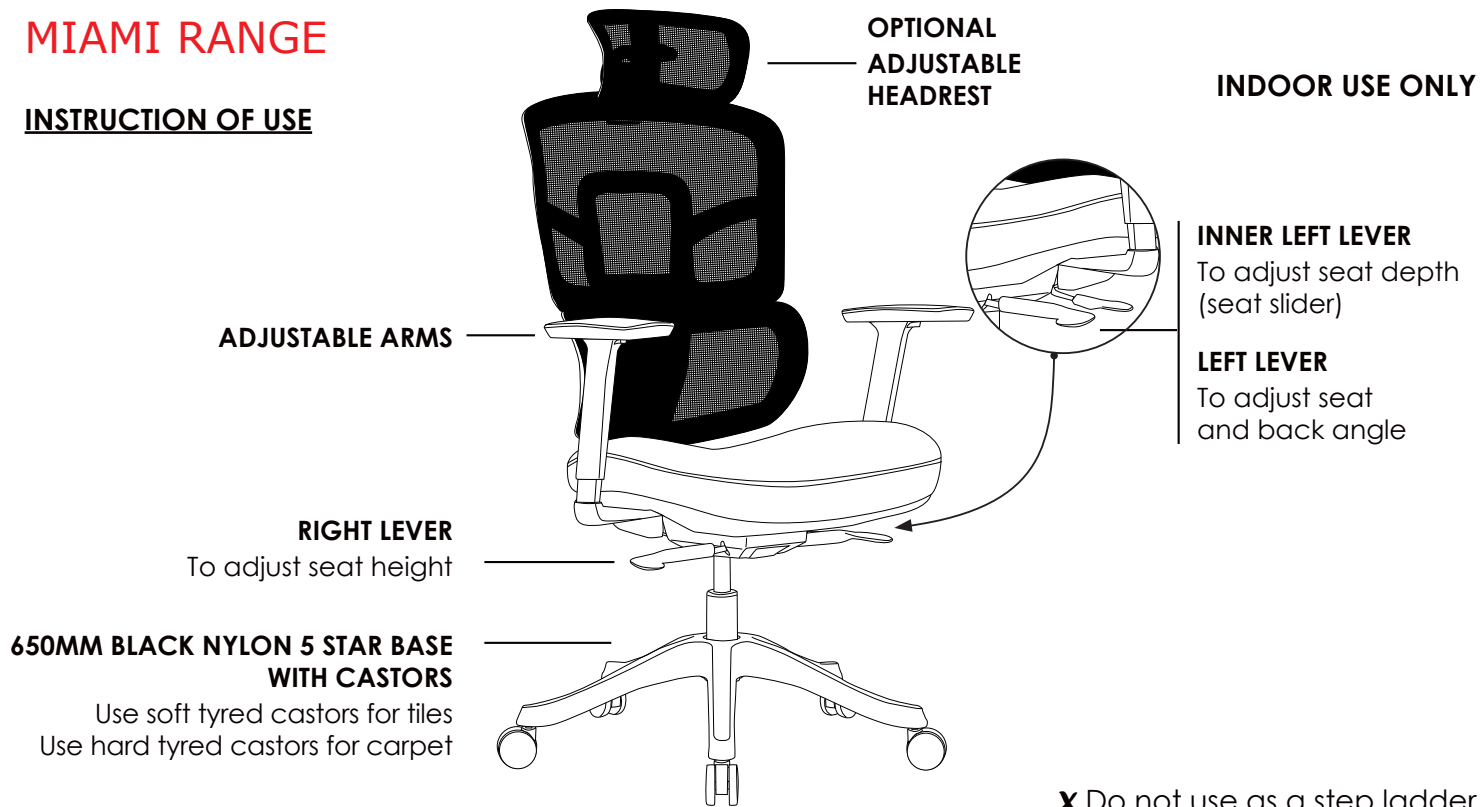

DIMENSIONS: (mm)

BACK **BACK TO FLOOR**
W: 500 Lowest: 1025
H: 585 Highest: 1100

HEADREST **HEADREST TO FLOOR**
W: 300 Lowest: 1095
H: 150 Highest: 1270

SEAT **SEAT TO FLOOR**
W: 520 Lowest: 465
D: 500 Highest: 550

ARM TO FLOOR
Lowest: 660
Highest: 745

* Please note that the Headrest should not be used to manoeuvre the chair.



MIAMI-H



MIAMI-L



Back view

Features:

Adjustable seat height
Adjustable seat and back angle
Adjustable seat depth (seat slider)
Active lumbar

Adjustable arms
Auto weight tensioning
Synchron mechanism with 3 locking positions
650mm black nylon 5 star base

Available in black only
Suitable for indoor use only



BRAGG RANGE

INSTRUCTION OF USE

INDOOR USE ONLY

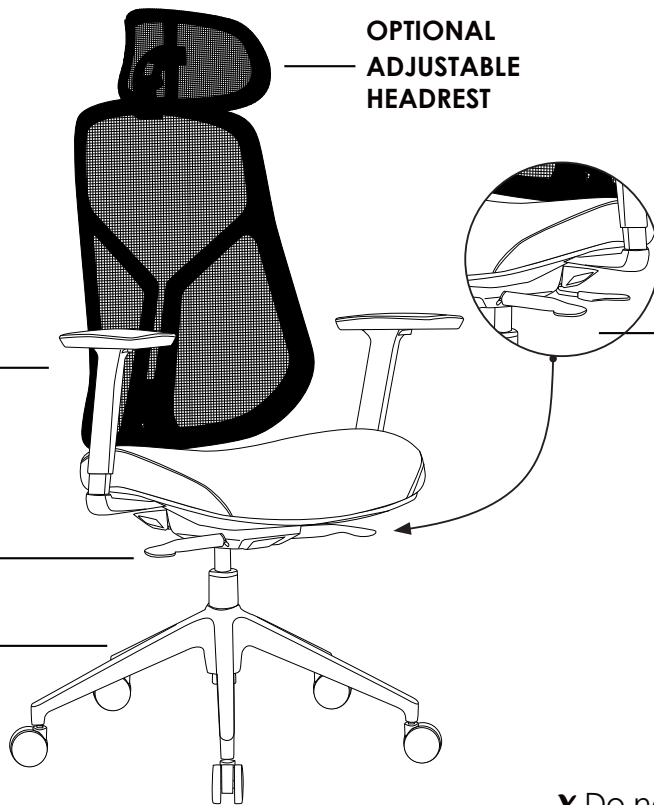

**OPTIONAL
ADJUSTABLE
HEADREST**

ADJUSTABLE ARMS

INNER LEFT LEVER
To adjust seat depth
(seat slider)

RIGHT LEVER
To adjust seat height

LEFT LEVER
To adjust seat
and back angle

**640MM BLACK HIGH ARCH 5 STAR
BASE WITH CASTORS**

Use soft tyred castors for tiles
Use hard tyred castors for carpet

X Do not use as a step ladder

DIMENSIONS: (mm)

BACK BACK TO FLOOR

W: 470 Lowest: 1075
H: 650 Highest: 1150

HEADREST

W: 320
H: 190

HEADREST TO FLOOR

Lowest: 1210
Highest: 1370

SEAT

W: 510
D: 510

SEAT TO FLOOR

Lowest: 495
Highest: 570

ARM TO FLOOR

Lowest: 660
Highest: 810

* Please note that the Headrest should not be used to manoeuvre the chair.



BRAGG-H



BRAGG-L



Back view

Features:

Adjustable seat height
Adjustable seat and back angle
Adjustable seat depth (seat slider)
Adjustable arms

Auto weight tensioning
Synchron mechanism with 3 locking positions
640mm black high arch 5 star base

Available in black only
Suitable for indoor use only



KUBE RANGE

INSTRUCTION OF USE

INDOOR USE ONLY



DIMENSIONS: (mm)

BACK **BACK TO FLOOR**
W: 470 Lowest: 1010
H: 590 Highest: 1090

HEADREST **HEADREST TO FLOOR**
W: 360 Lowest: 1190
H: 170 Highest: 1260

SEAT **SEAT TO FLOOR**
W: 490 Lowest: 450
D: 490 Highest: 530

ARM TO FLOOR
Lowest: 640
Highest: 775

* Please note that the Headrest should not be used to manoeuvre the chair.



KUBE-H



KUBE-L



Back view

Features:

Adjustable seat height
Adjustable seat and back angle
Adjustable seat depth (seat slider)
Adjustable weight tension

Adjustable lumbar
3-Way adjustable arms
Synchron mechanism with 3 locking positions
670mm black nylon 5 star base



Available in black only
BIFMA tested
Suitable for indoor use only

RAZOR RANGE

INSTRUCTION OF USE

INDOOR USE ONLY

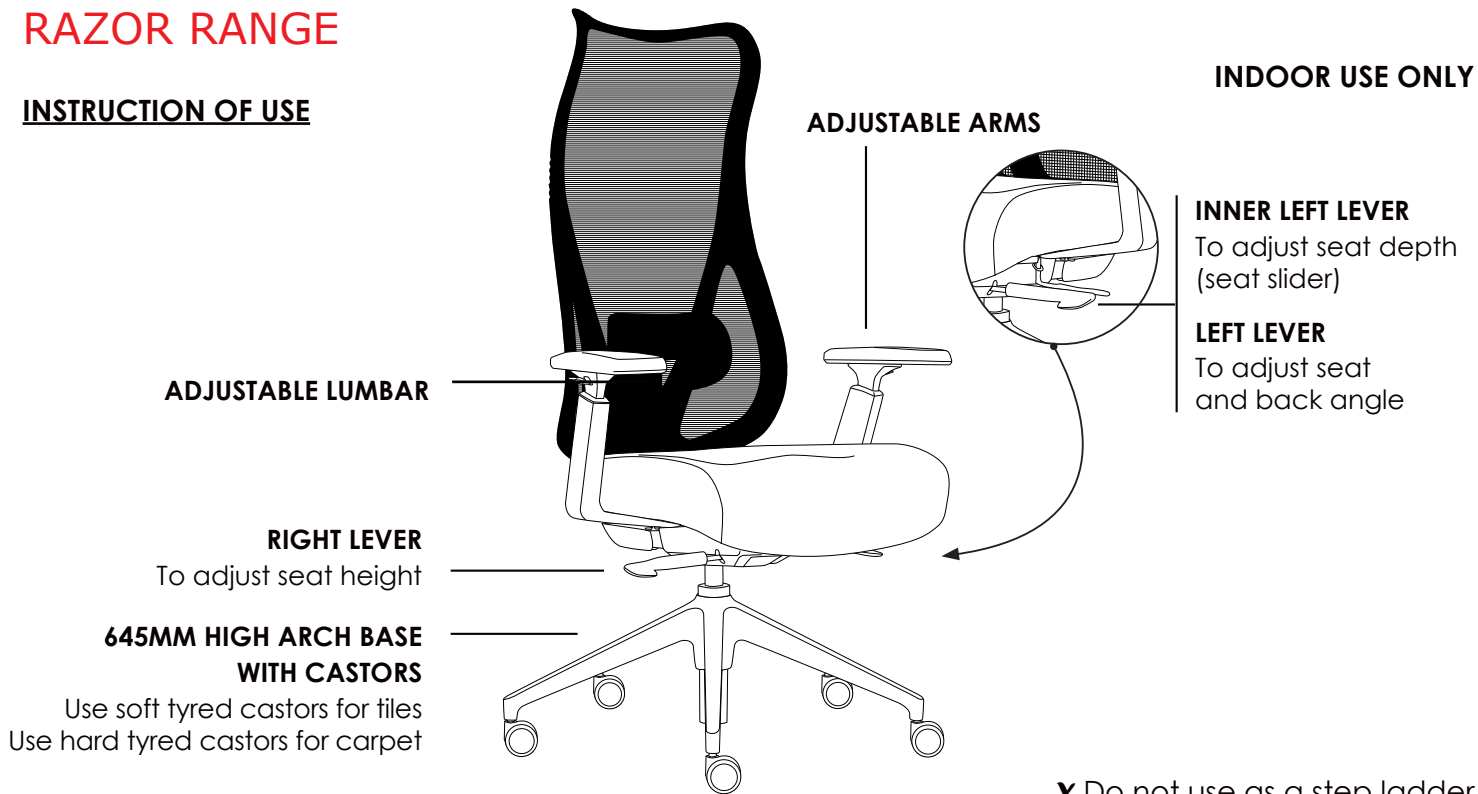

DIMENSIONS: (mm)

BACK	BACK TO FLOOR	SEAT	SEAT TO FLOOR	ARM TO FLOOR
W: 510	Lowest: 1180	W: 500	Lowest: 470	Lowest: 680
H: 710	Highest: 1240	D: 505	Highest: 530	Highest: 745

* Please note that the Headrest should not be used to manoeuvre the chair.



RAZOR



Side view



Back view

Features:

Adjustable seat height
Adjustable seat and back angle
Adjustable seat depth (seat slider)
Adjustable lumbar
Adjustable arms

Auto weight tensioning
Big boy seat
Memory seat foam
Synchron mechanism with 3 locking positions

645mm black nylon 5 star base
Available in black only
Suitable for indoor use only



MITZ RANGE

INSTRUCTION OF USE

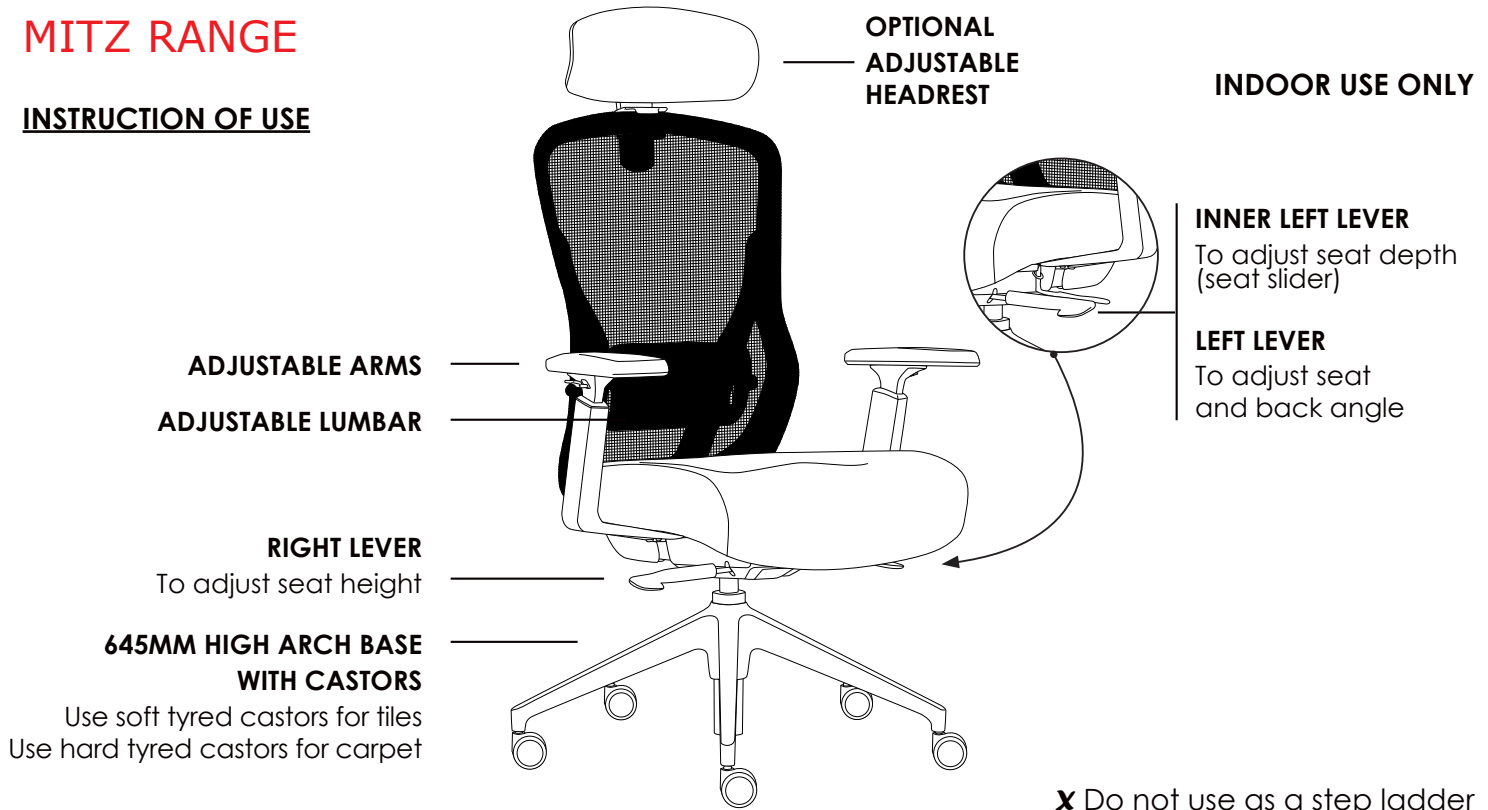

DIMENSIONS: (mm)

BACK **BACK TO FLOOR**
W: 520 Lowest: 1060
H: 570 Highest: 1180

HEADREST **HEADREST TO FLOOR**
W: 320 Lowest: 1210
H: 150 Highest: 1330

SEAT **SEAT TO FLOOR**
W: 515 Lowest: 470
D: 480 Highest: 590

ARM TO FLOOR
Lowest: 645
Highest: 720

* Please note that the Headrest should not be used to manoeuvre the chair.



MITZ-H



MITZ-L



Back view

Features:

Adjustable seat height
Adjustable seat and back angle
Adjustable seat depth (seat slider)
Adjustable lumbar
Adjustable arms

Auto weight tensioning
Big boy seat
Memory seat foam
Synchron mechanism with 3 locking positions

645mm black nylon 5 star base
Available in black only
Suitable for indoor use only



IVORY RANGE

INSTRUCTION OF USE

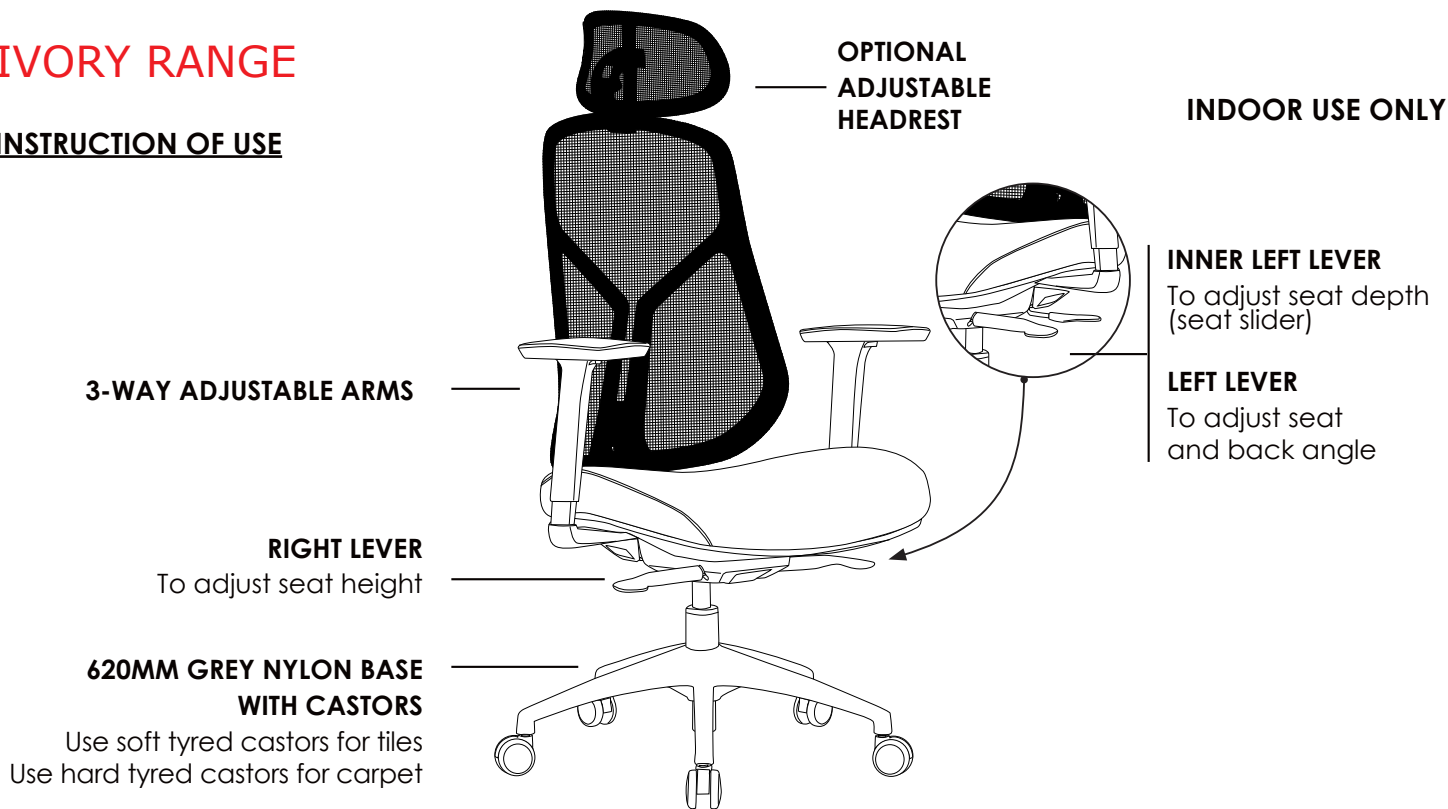

DIMENSIONS: (mm)

BACK **BACK TO FLOOR**
W: 470 Lowest: 1060
H: 650 Highest: 1150

HEADREST **HEADREST TO FLOOR**
W: 320 Lowest: 1075
H: 190 Highest: 1325

SEAT **SEAT TO FLOOR**
W: 510 Lowest: 485
D: 510 Highest: 575

ARM TO FLOOR
Lowest: 655
Highest: 820

* Please note that the Headrest should not be used to manoeuvre the chair.



IVORY-H



IVORY-L



Back view

Features:

Adjustable seat height
Adjustable seat and back angle
Adjustable seat depth (seat slider)
3-Way adjustable arms

Auto weight tensioning
Synchron mechanism with 3 locking positions
620mm grey nylon 5 star base

Available in grey only
Suitable for indoor use only



BAXTER RANGE

INSTRUCTION OF USE

INDOOR USE ONLY

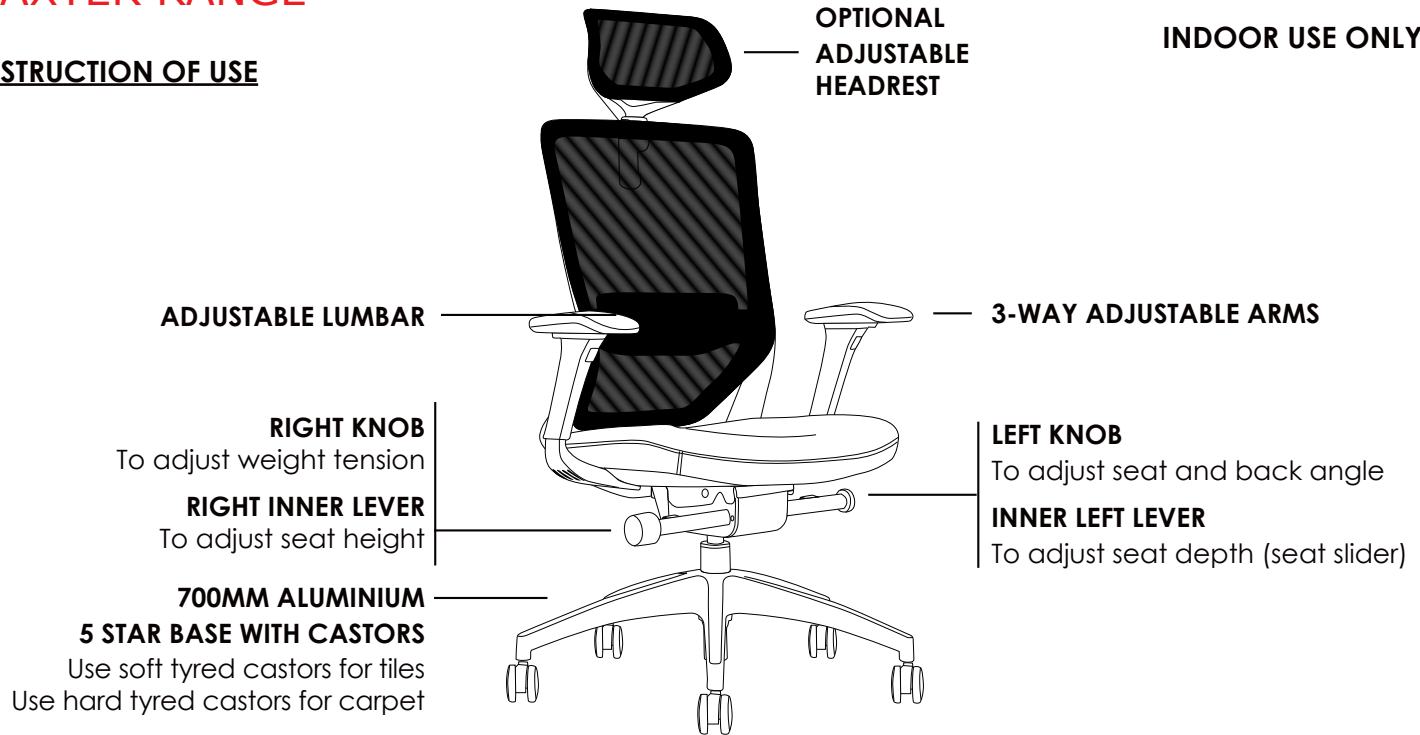

X Do not use as a step ladder

DIMENSIONS: (mm)

BACK	BACK TO FLOOR	HEADREST	HEADREST TO FLOOR	SEAT	SEAT TO FLOOR	ARM TO FLOOR
W: 475	Lowest: 1025	W: 330	Lowest: 1130	W: 500	Lowest: 470	Lowest: 670
H: 585	Highest: 1120	H: 200	Highest: 1385	D: 510	Highest: 565	Highest: 830

* Please note that the Headrest should not be used to manoeuvre the chair.



BAXTER-H



BAXTER-L



Back view

Features:

Adjustable seat height
Adjustable seat and back angle
Adjustable seat depth (seat slider)
Adjustable weight tension

Adjustable lumbar
3-Way adjustable arms
Synchron mechanism with 3 locking positions
700mm aluminium 5 star base

Available in black only
BIFMA tested
Suitable for indoor use only



EVITA RANGE

INSTRUCTION OF USE

INDOOR USE ONLY

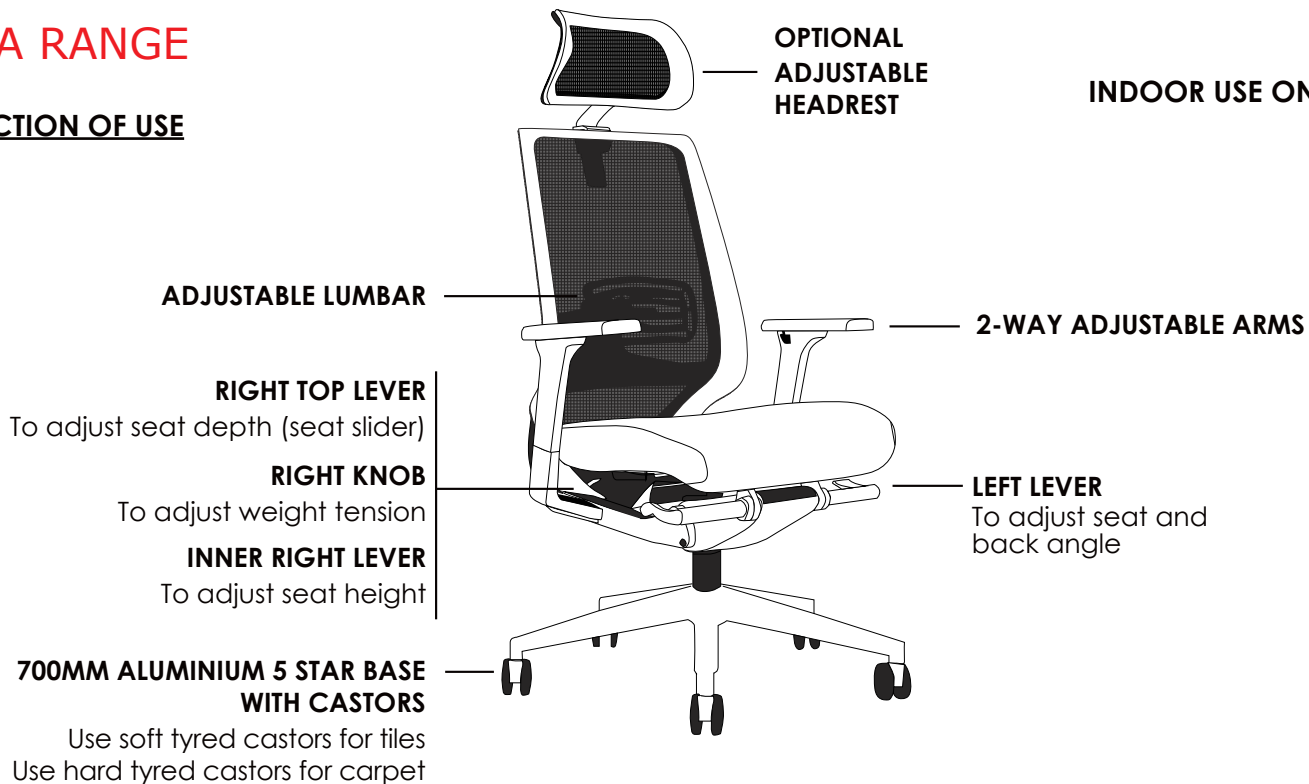

X Do not use as a step ladder

DIMENSIONS: (mm)

BACK **BACK TO FLOOR**
W: 415 Lowest: 1005
H: 560 Highest: 1125

HEADREST **HEADREST TO FLOOR**
W: 340 Lowest: 1225
H: 180 Highest: 1380

SEAT **SEAT TO FLOOR**
W: 490 Lowest: 490
D: 460 Highest: 610

ARM TO FLOOR
Lowest: 640
Highest: 825

* Please note that the Headrest should not be used to manoeuvre the chair.



EVITA-H



EVITA-L



Back view

Features:

Adjustable seat height
Adjustable seat and back angle
Adjustable seat depth (seat slider)
Adjustable weight tension

Adjustable lumbar
2-Way adjustable arms
Moulded seat foam
Korean mesh back

Synchron mechanism with 3 locking positions
700mm aluminium 5 star base
Available in black only
BIFMA tested
Suitable for indoor use only



ZODIAC RANGE

INSTRUCTION OF USE

To adjust back height hold back with two hands while seated and raise to desired height

To lower the back height raise back all the way to the top and release slowly

ADJUSTABLE ARMS

RIGHT LEVER

To adjust seat height

700MM ALUMINIUM 5 STAR BASE WITH CASTORS

Use soft tyred castors for tiles
Use hard tyred castors for carpet

**OPTIONAL
ADJUSTABLE
HEADREST**

INDOOR USE ONLY

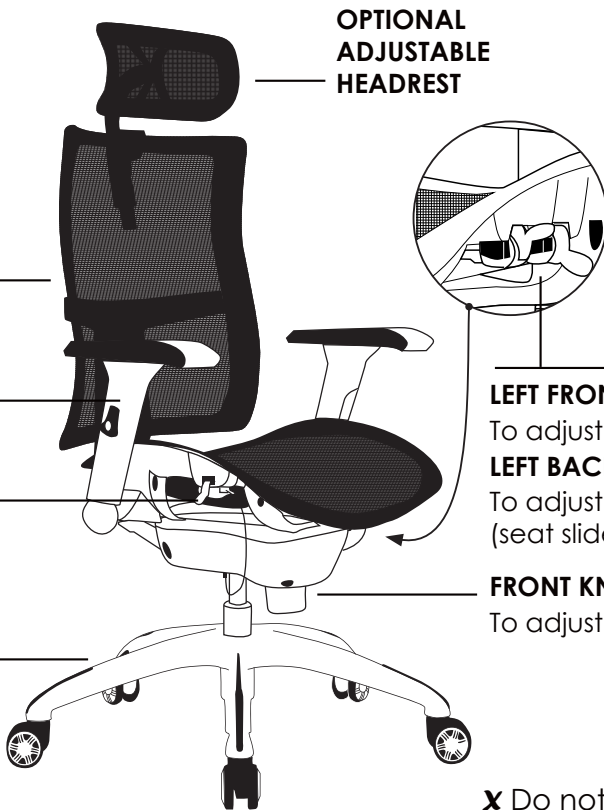

LEFT FRONT LEVER

To adjust back angle

LEFT BACK LEVER

To adjust seat depth
(seat slider)

FRONT KNOB

To adjust weight tension

X Do not use as a step ladder

DIMENSIONS: (mm)

BACK BACK TO FLOOR

W: 455 Lowest: 990

H: 550 Highest: 1150

HEADREST

W: 380

H: 180

HEADREST TO FLOOR

Lowest: 1140

Highest: 1350

SEAT

W: 500

D: 490

SEAT TO FLOOR

Lowest: 515

Highest: 610

ARM TO FLOOR

Lowest: 670

Highest: 840

* Please note that the Headrest should not be used to manoeuvre the chair.



ZODIAC-H



ZODIAC-L



Back view

Features:

- Adjustable seat height cable controlled
- Adjustable back height (ratchet)
- Adjustable seat and back angle cable controlled
- Adjustable seat depth (seat slider) cable controlled
- Adjustable weight tension

- 2-Way adjustable arms
- Synchron mechanism with 3 locking positions
- 700mm aluminium 5 star base
- Available in black only
- BIFMA tested
- Suitable for indoor use only



ERGO-1 RANGE

INSTRUCTION OF USE

To adjust back height hold back with two hands while seated and raise to desired height

To lower the back height raise back all the way to the top and release slowly

RIGHT BACK LEVER

To adjust seat depth (seat slider)

RIGHT FRONT LEVER

To adjust seat height

RIGHT KNOB

To adjust weight tension

700MM ALUMINIUM 5 STAR BASE WITH CASTORS

Use soft tyred castors for tiles
Use hard tyred castors for carpet

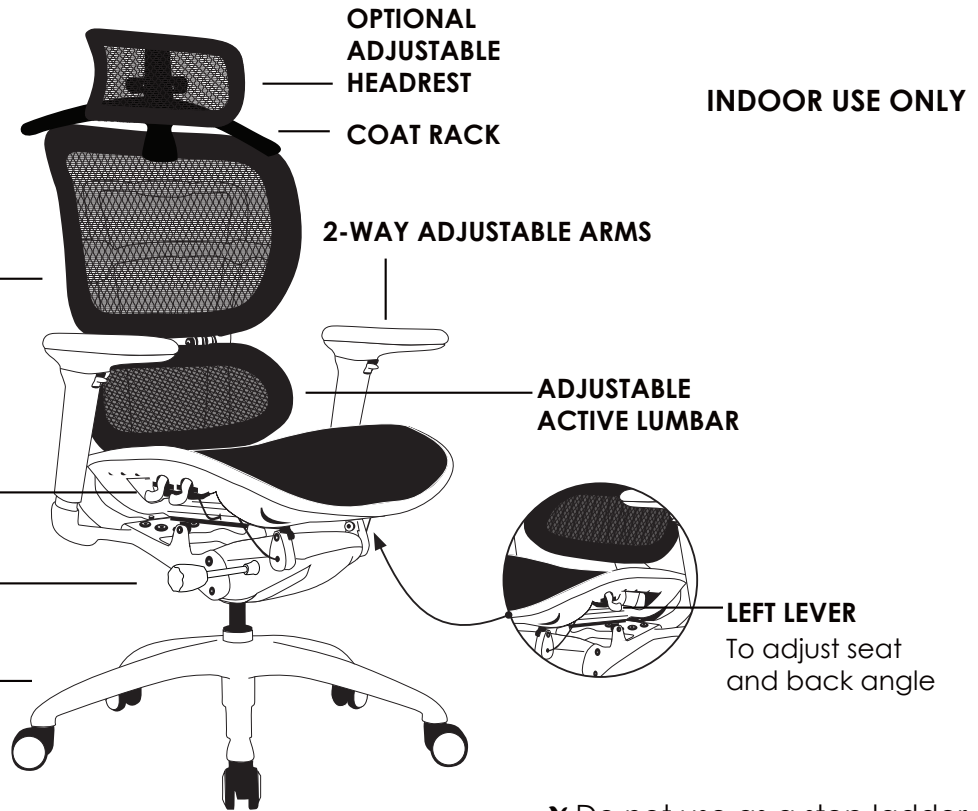

X Do not use as a step ladder

DIMENSIONS: (mm)

BACK BACK TO FLOOR

W: 530 Lowest: 1110

H: 640 Highest: 1190

HEADREST

W: 300

H: 180

HEADREST TO FLOOR

Lowest: 1245

Highest: 1400

SEAT

W: 520

D: 500

SEAT TO FLOOR

Lowest: 500

Highest: 590

ARM TO FLOOR

Lowest: 660

Highest: 820

* Please note that the Headrest should not be used to manoeuvre the chair.



ERGO-1H



ERGO-1L



Back view

Features:

- Adjustable seat height cable controlled
- Adjustable back height (ratchet)
- Adjustable seat and back angle cable controlled
- Adjustable seat depth (seat slider) cable controlled
- Adjustable weight tension
- Adjustable active lumbar

- 2-Way adjustable arms
- Synchron mechanism with 3 locking positions
- 700mm aluminium 5 star base
- Available in black only
- BIFMA tested
- Suitable for indoor use only



HILTON RANGE

INSTRUCTION OF USE

INDOOR USE ONLY

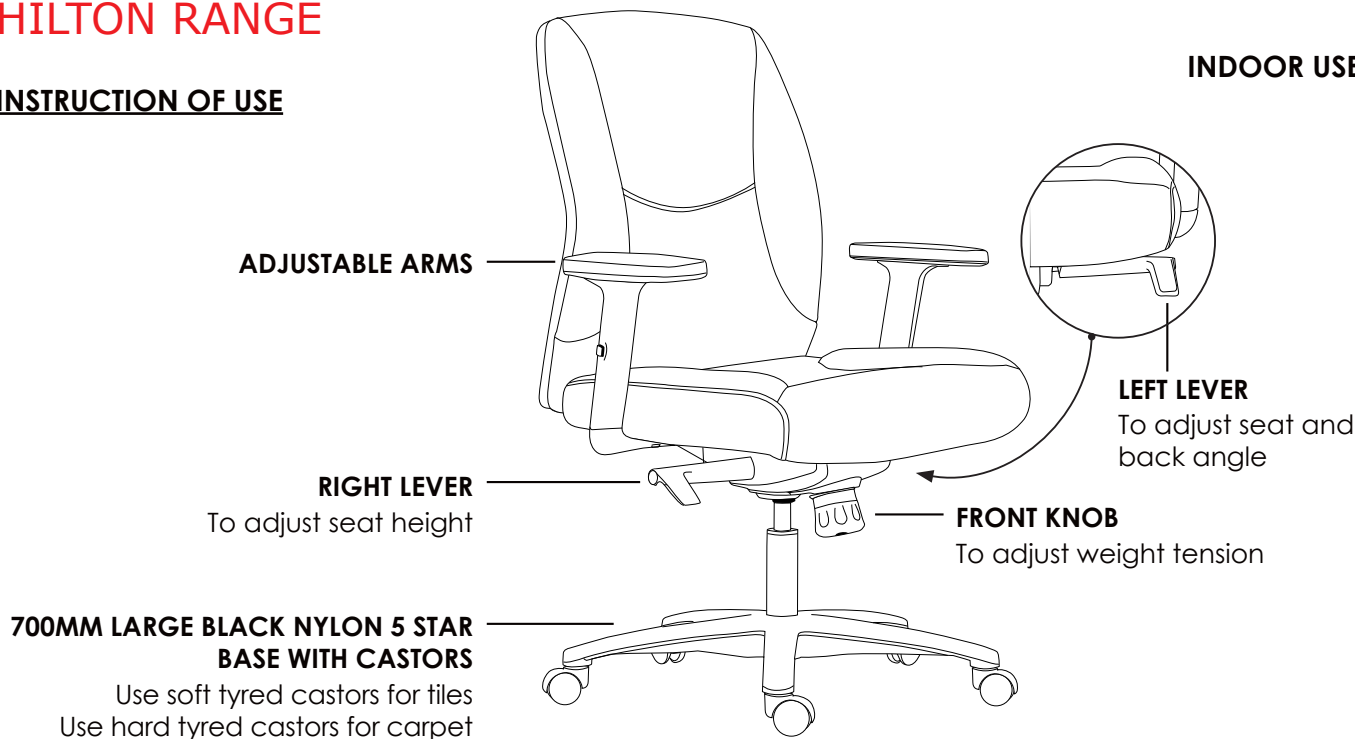

X Do not use as a step ladder

DIMENSIONS: (mm)

LOW BACK **BACK TO FLOOR**
W: 420 Lowest: 980
H: 500 Highest: 1070

HIGH BACK **BACK TO FLOOR**
W: 420 Lowest: 1110
H: 660 Highest: 1200

SEAT **SEAT TO FLOOR**
W: 510 Lowest: 480
D: 510 Highest: 570

ARM TO FLOOR
Lowest: 660
Highest: 830



HILTON-H



HILTON-L



HILTON-VC

Black metal frame
Available in black PU only
Suitable for indoor use only

Features:

Adjustable seat height
Adjustable seat and back angle
Adjustable weight tension

Adjustable arms
Synchron mechanism with 3 locking positions
700mm large black nylon 5 star base

Available in black PU only
Suitable for indoor use



CRUZ RANGE

INSTRUCTION OF USE

INDOOR USE ONLY

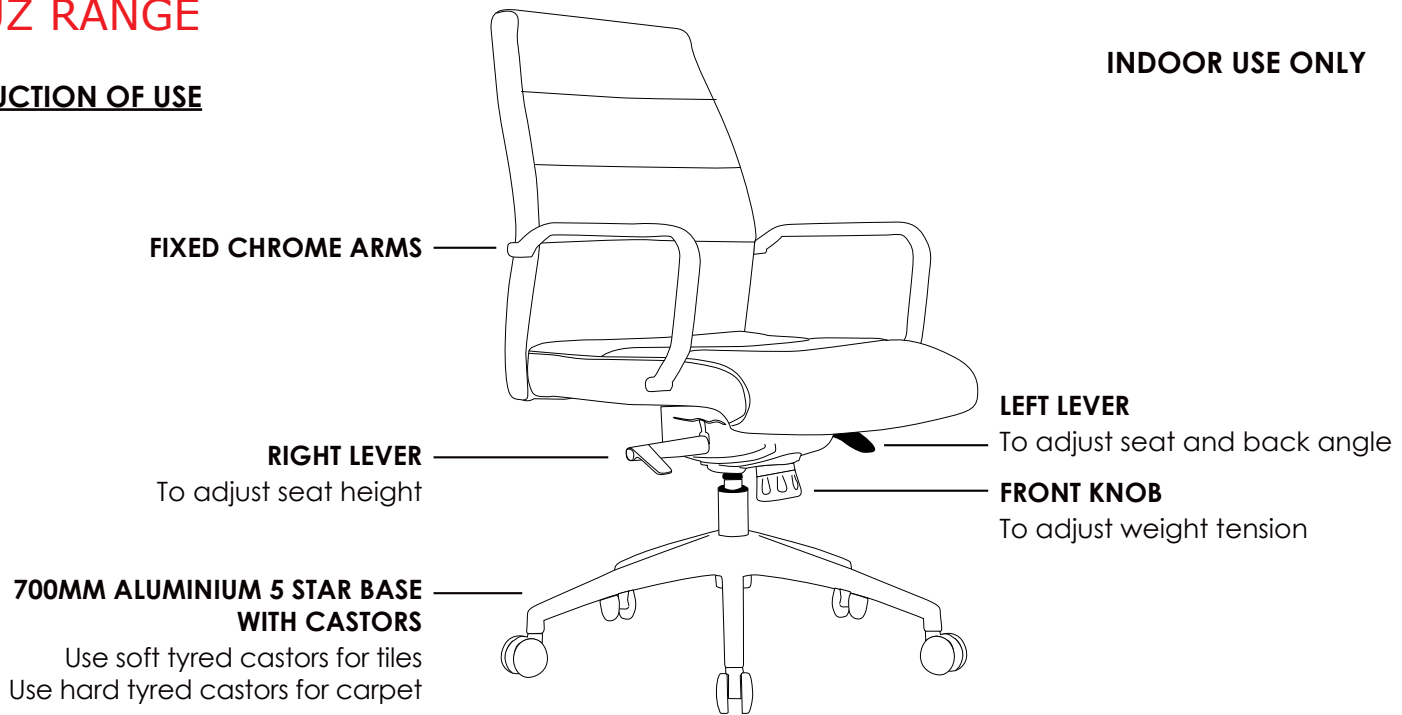

X Do not use as a step ladder

DIMENSIONS: (mm)

LOW BACK	BACK TO FLOOR	HIGH BACK	BACK TO FLOOR	SEAT	SEAT TO FLOOR	ARM TO FLOOR
W: 560	Lowest: 980	W: 560	Lowest: 1150	W: 520	Lowest: 485	Lowest: 680
H: 515	Highest: 1055	H: 680	Highest: 1225	D: 560	Highest: 560	Highest: 755



CRUZ-H



CRUZ-L



Back view

Features:

Adjustable seat height
Adjustable seat and back angle
Adjustable weight tension

Fixed chrome arms
Knee tilt mechanism with 3 locking positions
700mm aluminium 5 star base

Available in black PU only
Suitable for indoor use only



BOSTON RANGE

INSTRUCTION OF USE

INDOOR USE ONLY

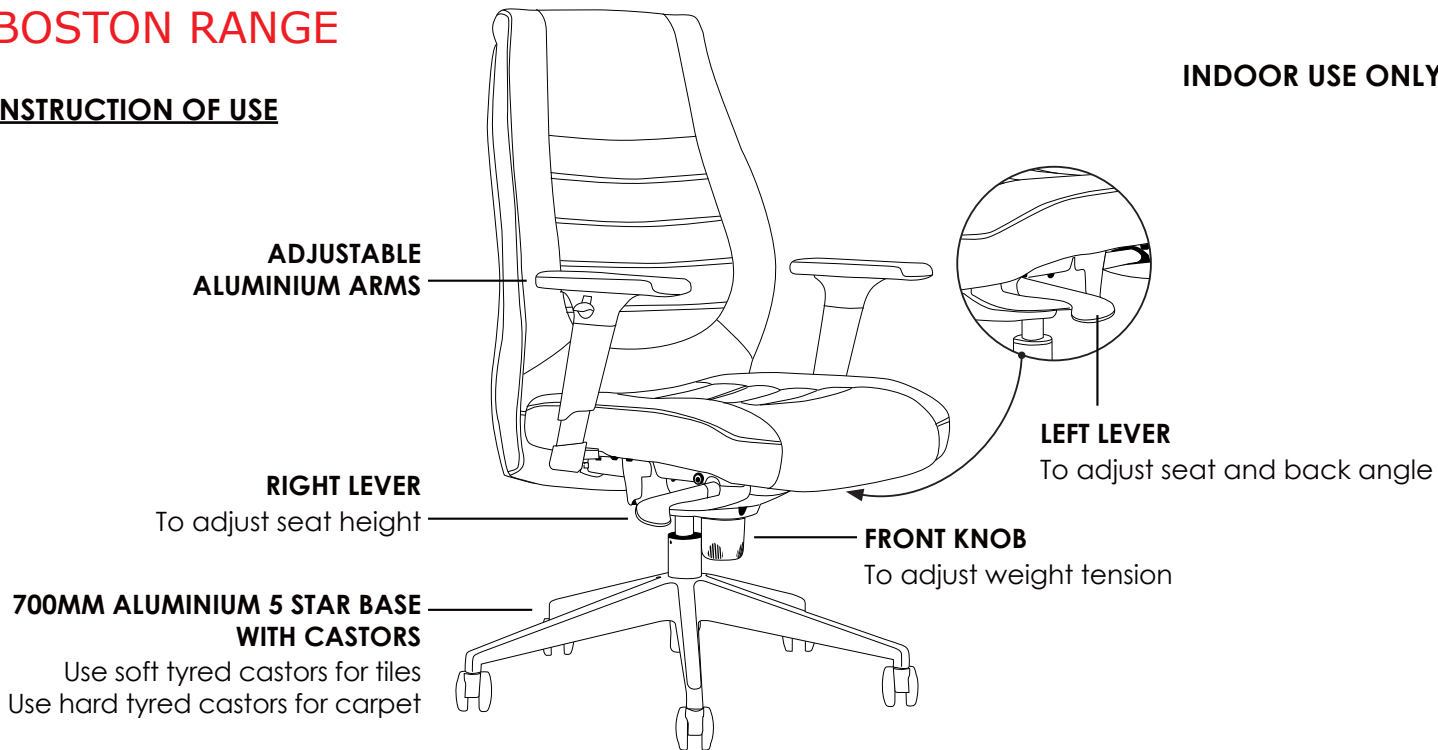

X Do not use as a step ladder

DIMENSIONS: (mm)

LOW BACK **BACK TO FLOOR**
W: 480 Lowest: 1025
H: 580 Highest: 1085

HIGH BACK **BACK TO FLOOR**
W: 500 Lowest: 1170
H: 720 Highest: 1230

SEAT **SEAT TO FLOOR**
W: 510 Lowest: 455
D: 520 Highest: 515

ARM TO FLOOR
Lowest: 640
Highest: 770



BOSTON-H



BOSTON-L



BOSTON-VC

Chrome frame
High density foam
Available in black PU only
Suitable for indoor use only

Features:

Adjustable seat height
Adjustable seat and back angle
Adjustable weight tension
Adjustable aluminium arms

High density foam
Synchron mechanism with 3 locking positions
700mm aluminium 5 star base

Available in black PU only
Suitable for indoor use only

WARRANTY 5 Year
WEIGHT LIMIT 120 Kilogram
IMPORTED

CAMRY RANGE

INSTRUCTION OF USE

INDOOR USE ONLY

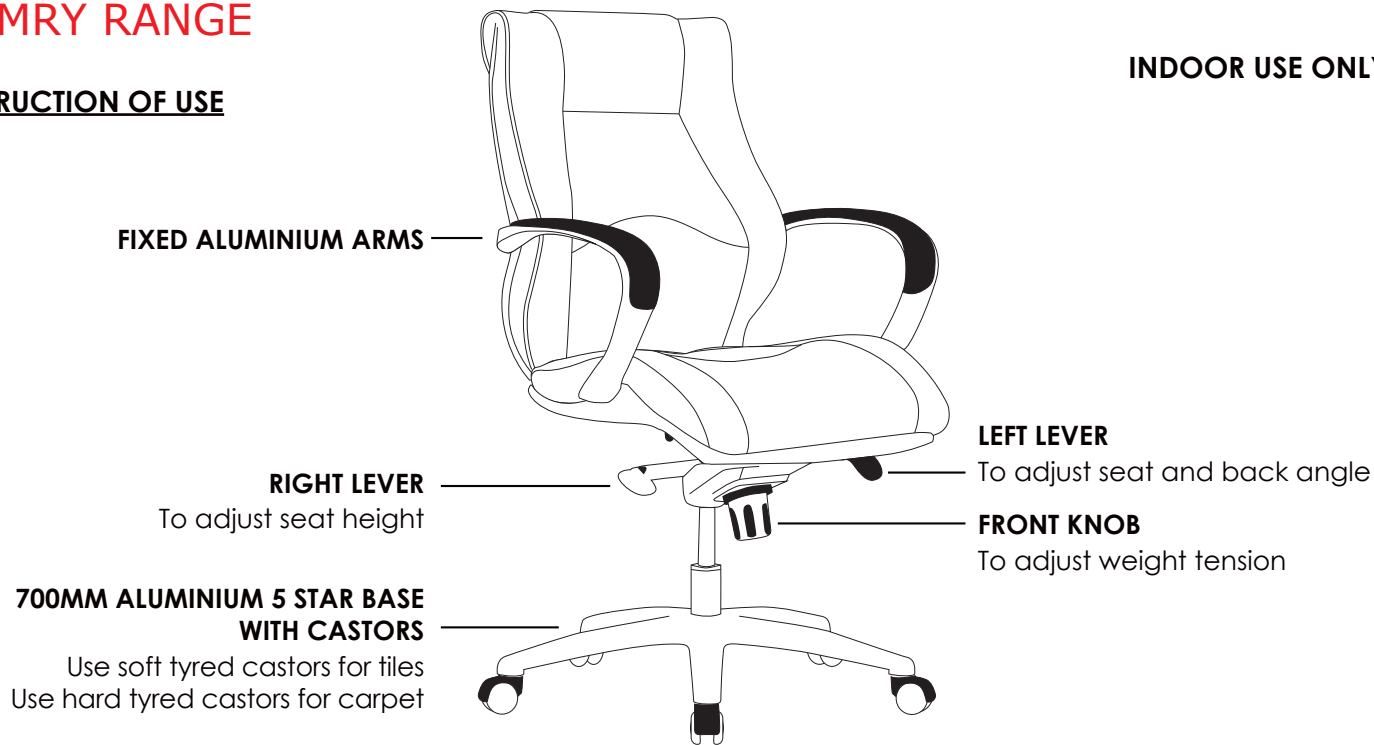

X Do not use as a step ladder

DIMENSIONS: (mm)

LOW BACK **BACK TO FLOOR**
W: 500 Lowest: 1045
H: 570 Highest: 1125

HIGH BACK **BACK TO FLOOR**
W: 500 Lowest: 1190
H: 730 Highest: 1270

SEAT **SEAT TO FLOOR**
W: 510 Lowest: 510
D: 530 Highest: 590

ARM TO FLOOR
Lowest: 710
Highest: 790



CAMRY-H



CAMRY-L

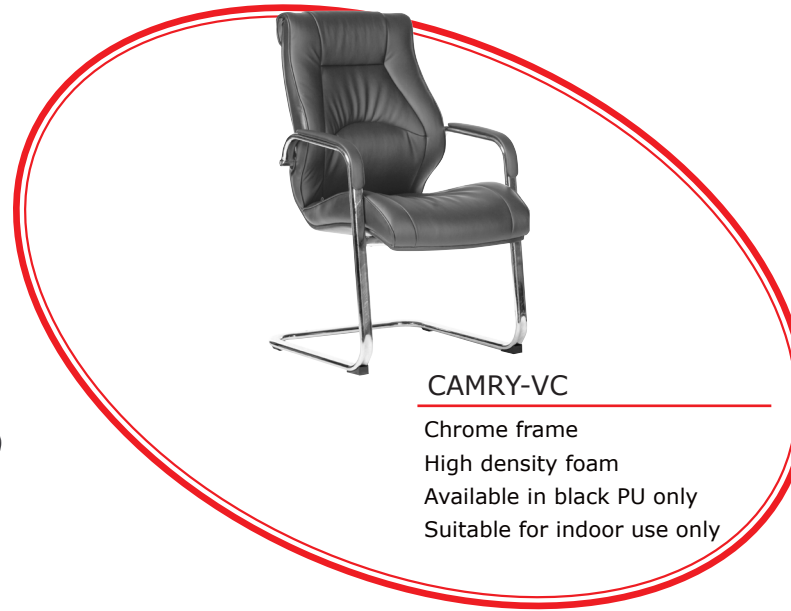

CAMRY-VC

Chrome frame
High density foam
Available in black PU only
Suitable for indoor use only

Features:

Adjustable seat height
Adjustable seat and back angle
Adjustable weight tension
Fixed aluminium arms

High density foam
Knee tilt mechanism with 3 locking positions
700mm aluminium 5 star base

Available in black PU only
Suitable for indoor use only



SIENA RANGE

INSTRUCTION OF USE

INDOOR USE ONLY

ADJUSTABLE ARMS

RIGHT KNOB
To adjust weight tension

INNER RIGHT LEVER
To adjust seat height

**700MM BLACK ALUMINIUM
5 STAR BASE WITH CASTORS**
Use soft tyred castors for tiles
Use hard tyred castors for carpet

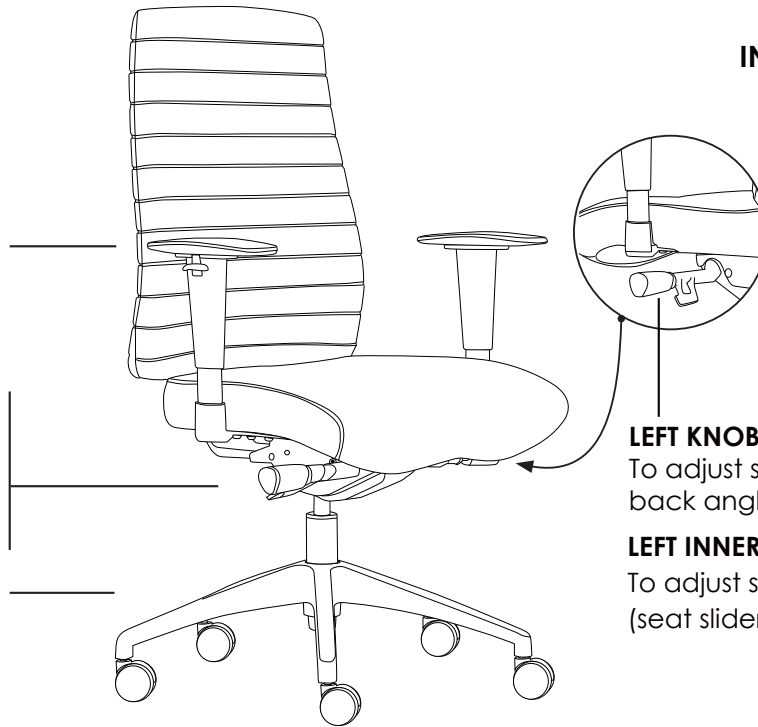

LEFT KNOB
To adjust seat and
back angle

LEFT INNER LEVER
To adjust seat depth
(seat slider)

X Do not use as a step ladder

DIMENSIONS: (mm)

LOW BACK **BACK TO FLOOR**
W: 460 Lowest: 995
H: 550 Highest: 1095

HIGH BACK **BACK TO FLOOR**
W: 460 Lowest: 1130
H: 685 Highest: 1230

SEAT **SEAT TO FLOOR**
W: 510 Lowest: 480
D: 490 Highest: 580

ARM TO FLOOR
Lowest: 650
Highest: 840



SIENA-H



SIENA-L



Back view

WARRANTY 5 Year	WEIGHT LIMIT 130 Kilogram	IMPORTED
------------------------------	--	--------------

Features:

Adjustable seat height
Adjustable seat and back angle
Adjustable seat depth (seat slider)
Adjustable weight tension
Adjustable arm

Saddle seat
Ribbed back
Synchron mechanism with 3 locking positions
700mm black aluminium 5 star base

Available in black PU only
Suitable for indoor use only

SELECT RANGE

INSTRUCTION OF USE

INDOOR USE ONLY

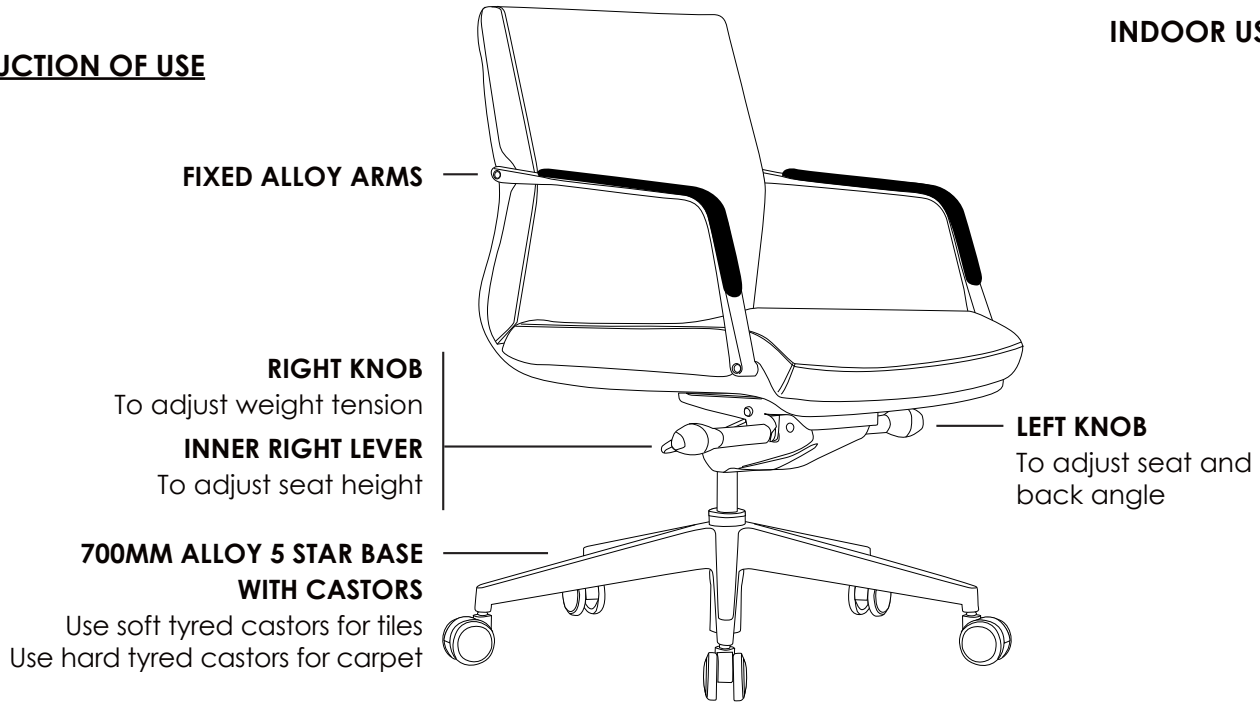

X Do not use as a step ladder

DIMENSIONS: (mm)

LOW BACK **BACK TO FLOOR**
W: 470 Lowest: 910
H: 500 Highest: 990

HIGH BACK **BACK TO FLOOR**
W: 470 Lowest: 1080
H: 670 Highest: 1160

SEAT **SEAT TO FLOOR**
W: 500 Lowest: 450
D: 500 Highest: 530

ARM TO FLOOR
Lowest: 650
Highest: 730



SELECT-H



SELECT-L



Back view

Features:

Adjustable seat height
Adjustable seat and back angle
Adjustable weight tension

Fixed alloy arms
Knee tilt mechanism with 4 locking positions
700mm alloy 5 star base

Available in leather only
Suitable for indoor use only

Three icons in a row: a red shield with 'WARRANTY 5 Year', a black shield with 'WEIGHT LIMIT 130 Kilogram', and a black shield with 'IMPORTED' and a globe.

MAGNUM RANGE

INDOOR USE ONLY

INSTRUCTION OF USE

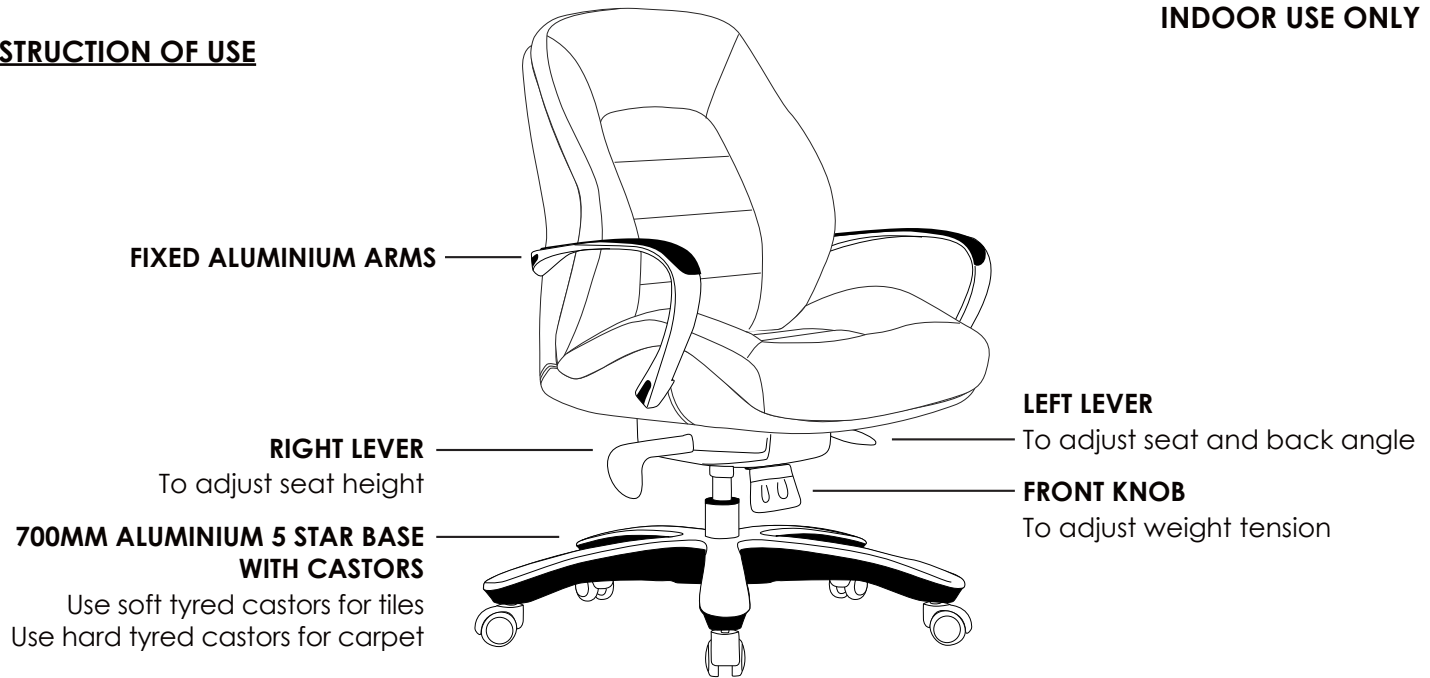

X Do not use as a step ladder

DIMENSIONS: (mm)

LOW BACK **BACK TO FLOOR**
W: 560 Lowest: 1000
H: 565 Highest: 1070

HIGH BACK **BACK TO FLOOR**
W: 560 Lowest: 1210
H: 800 Highest: 1275

SEAT **SEAT TO FLOOR**
W: 550 Lowest: 450
D: 500 Highest: 510

ARM TO FLOOR
Lowest: 660
Highest: 730



MAGNUM-H



MAGNUM-L



Back view

Features:

Adjustable seat height
Adjustable seat and back angle
Adjustable weight tension
Fixed aluminium arms

Moulded seat and back foam
Knee tilt mechanism with 3 locking positions
700mm aluminium 5 star base
Extremely comfortable

Available in black leather only
Suitable for indoor use only



CAPTAIN RANGE

INSTRUCTION OF USE

INDOOR USE ONLY

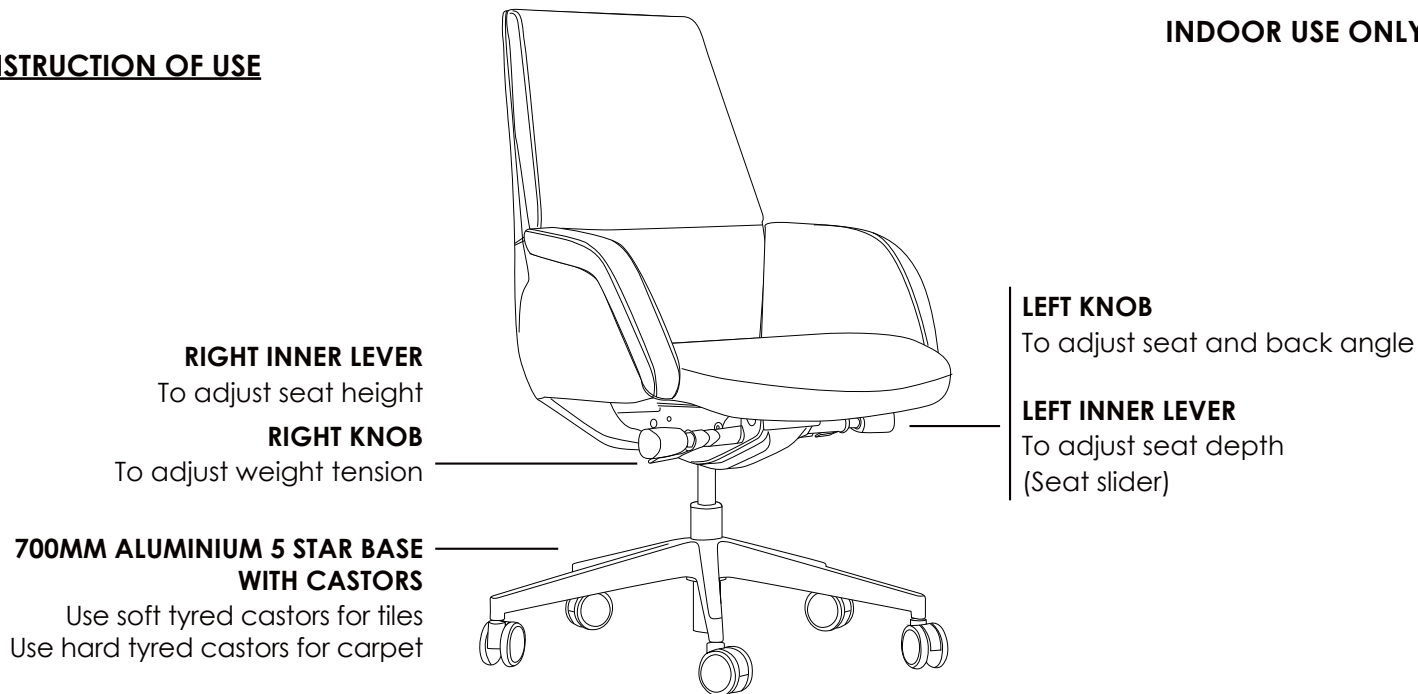

X Do not use as a step ladder

DIMENSIONS: (mm)

LOW BACK **BACK TO FLOOR**
W: 550 Lowest: 970
H: 510 Highest: 1030

HIGH BACK **BACK TO FLOOR**
W: 550 Lowest: 1150
H: 700 Highest: 1210

SEAT **SEAT TO FLOOR**
W: 570 Lowest: 470
D: 510 Highest: 530

ARM TO FLOOR
Lowest: 640
Highest: 700



CAPTAIN-H



CAPTAIN-L



Back view

Features:

Adjustable seat height
Adjustable seat and back angle
Adjustable weight tension

Adjustable seat depth (seat slider)
Synchron mechanism with 3 locking positions
700mm aluminium 5 star base

Extremely comfortable
Available in black leather only
Suitable for indoor use only



FOCUS RANGE



FOC-1



FOC-1A

DIMENSIONS: (mm)

BACK	SEAT	OVERALL	ARM WIDTH	TABLET ARM	ARM TO FLOOR	TABLET ARM TO FLOOR
W: 490 H: 435	W: 465 D: 440	H: 840 D: 550 W: 525	Inner: 510 Outer: 610	W: 610 D: 660	H: 680	H: 745 Flip up: 1010



FOC-1TR



FOC-1TL



Trolley available

Features:

Multi purpose stackable client chair
Not stackable with tablet arms
Optional black metal trolley
Linkable except with arms or tablet arm

Fully strengthened plastic back shell
Fully welded frame
BIFMA drop tested

Available in black only
Suitable for indoor use only
Do not use as a step ladder



ARIA RANGE



ARIA



ARIA-A



ARIA-T

DIMENSIONS: (mm)

BACK	SEAT	OVERALL	ARM WIDTH	ARM TO FLOOR	TABLET ARM	TABLET ARM TO FLOOR
W: 475	W: 475	H: 850	Inner: 525	H: 655	W: 380	H: 735
H: 395	D: 470	D: 515	Outer: 600		D: 270	
		W: 620				

Features:

Stackable
Not stackable with arms or tablet arm
Optional black metal trolley

Linkable without arms or tablet arm
Metal frame
Available in black only

Suitable for indoor use only
Do not use as a step ladder

POD RANGE

WARRANTY
4
 Year

WEIGHT LIMIT
120
 Kilogram

IMPORTED



POD-SB



POD-SBA



POD-SBT

Trolley available



DIMENSIONS: (mm)

BACK	SEAT	OVERALL	ARM WIDTH	ARM TO FLOOR	TABLET ARM	TABLET ARM TO FLOOR
W: 420 H: 380	W: 425 D: 400	H: 830 D: 530 W: 480	Inner: 440 Outer: 540	H: 670	W: 380 D: 280	H: 710 Flip up: 990

Features:

Stackable
 Not stackable with arm or tablet arm
 Optional black metal trolley

Linkable except with arms or tablet arm
 Plastic under pan
 Available in black only

Suitable for indoor use only
 Do not use as a step ladder

VINN RANGE



VINN-B



VINN-BA



VINN-BT

DIMENSIONS: (mm)

BACK	SEAT	OVERALL
W: 435	W: 455	H: 830
H: 390	D: 435	D: 545
		W: 530

ARM WIDTH	ARM TO FLOOR
Inner: 485	H: 665
Outer: 570	

TABLET ARM	TABLET ARM TO FLOOR
W: 380	H: 695
D: 290	Flip up: 900



VINN-MB



VINN-MBA



VINN-MBT



Features:

Stackable
Not stackable with tablet arms
Optional black metal trolley

Linkable except with arms or tablet arm
Plastic under pan
Solid steel sled base frame

Available in black only
Suitable for indoor use only
Do not use as a step ladder

WARRANTY 4 Year	WEIGHT LIMIT 120 Kilogram	IMPORTED 
------------------------------	--	---

NEO RANGE



NEO



Side view



Back view

Features:

Stackable
Square tube
Mesh back
Padded seat

Black metal frame
Available in black only
Suitable for indoor use only
Do not use as a step ladder



DIMENSIONS: (mm)

BACK	SEAT	SEAT TO FLOOR	OVERALL
W: 450	W: 415	H: 450	H: 830
H: 400	D: 450		D: 500
			W: 440

ROSE RANGE



ROSE



Side view



Back view

Features:

Soft padding
Polyurethane arm pads
Chrome finish
Fully welded frame

Available in black PU only
Suitable for indoor use only
Do not use as a step ladder



DIMENSIONS: (mm)

BACK	SEAT	SEAT TO FLOOR	ARM TO FLOOR	OVERALL
W: 470	W: 500	H: 500	H: 700	H: 940
H: 470	D: 450			D: 550
				W: 570

RAVEN RANGE



RAVEN-C



Side view



Back view

Features:

Fully upholstered
High density foam
Sled base chrome frame
Plywood shell

Available in Segra charcoal only
Suitable for indoor use only
Do not use as a step ladder



DIMENSIONS: (mm)

BACK	SEAT	SEAT TO FLOOR	OVERALL
W: 450	W: 470	H: 455	H: 855
H: 400	D: 410		D: 500
			W: 590

MIA RANGE



MIA



MIA-A



MIA-A
Side view

Features:

Fully upholstered
High density foam
Sled black frame
Plywood shell

Available in black PU only
Suitable for indoor use only
Do not use as a step ladder



DIMENSIONS: (mm)

BACK	SEAT	SEAT TO FLOOR	OVERALL
W: 480	W: 550	H: 455	H: 845
H: 390	D: 480		D: 550
			W: 480

TONIC RANGE



TONIC-C



Side view



Back view

Features:

Fully upholstered
High density seat foam
Moulded back foam
Solid rod Sled base chrome frame

Available in Segra charcoal only
Suitable for indoor use only
Do not use as a step ladder

DIMENSIONS: (mm)

SHELL
W: 640
H: 390

SEAT
W: 475
D: 490

SEAT TO FLOOR
H: 450

OVERALL
H: 755
D: 500
W: 590



OSCAR RANGE



OSCAR-C



Side view



Back view

Features:

High density foam
Sled base chrome frame
Plywood shell

Available in Segra charcoal only
Suitable for indoor use only
Do not use as a step ladder



DIMENSIONS: (mm)

SHELL	SEAT	SEAT TO FLOOR	OVERALL
W: 650	W: 580	H: 500	H: 820
H: 400	D: 450		D: 500
			W: 590

RAM RANGE



RAM



Front view



Back view

Features:

Fully upholstered
High density foam
Plywood structure

Available in black PU only
Suitable for indoor use only
Do not use as a step ladder

DIMENSIONS: (mm)

OVERALL	SEAT	SEAT TO FLOOR
H: 690	W: 500	H: 370
D: 740	D: 500	
W: 760		



NOX RANGE



NOX



Front view



Back view

Features:

Fully upholstered
High density foam
Plywood structure

Available in black PU only
Suitable for indoor use only
Do not use as a step ladder

DIMENSIONS: (mm)

OVERALL

H: 665
D: 735
W: 730

SEAT

W: 500
D: 500

SEAT TO FLOOR

H: 325



BLITZ RANGE



BLITZ-B



Side view



Back view

Features:

High density foam
Zig zag steel spring
Plywood frame
Chrome feet

Available in black PU
Suitable for indoor use only
Do not use as a step ladder



DIMENSIONS: (mm)

BACK	SEAT	SEAT TO FLOOR	OVERALL
W: 600	W: 610	H: 410	H: 750
H: 350	D: 525		D: 750
			W: 560

RIVET RANGE



RIVET-1



Front view



Back view

Features:

High density foam
Stainless steel frame
Solid timber inner frame

Available in black PU only
Suitable for indoor use only
Do not use as a step ladder

DIMENSIONS: (mm)

RIVET-1

W: 650mm
H: 810mm
D: 690mm

ARM TO FLOOR

630mm

SEAT TO FLOOR

435mm



JADEN RANGE

WEIGHT LIMIT
260
Kilogram



JADEN-2

WEIGHT LIMIT
130
Kilogram



JADEN-1



Back view

Features:

High density foam
Stainless steel frame
Solid timber inner frame

Available in black PU only
Suitable for indoor use only
Do not use as a step ladder



DIMENSIONS: (mm)

JADEN-1	JADEN-2	ARM TO FLOOR
W: 730mm	W: 1390mm	630mm
H: 810mm	H: 810mm	SEAT TO FLOOR
D: 730mm	D: 730mm	450mm

PLAZA RANGE

WEIGHT LIMIT
390
Kilogram



PL-3

WEIGHT LIMIT
260
Kilogram



PL-2

WEIGHT LIMIT
130
Kilogram



PL-1

Features:

Pocket spring seat
Loose cushions upholstered both sides
Zig zag steel spring
Webbed base
Solid hardwood frame

Stainless steel feet
Available in black PU only
Suitable for indoor use only

DIMENSIONS: (mm)

PL-1	PL-2	PL-3	ARM TO FLOOR
W: 835mm	W: 1400mm	W: 1970mm	655mm
H: 740mm	H: 740mm	H: 740mm	SEAT TO FLOOR
D: 790mm	D: 790mm	D: 790mm	475mm

STATE RANGE

INSTRUCTION OF USE

INDOOR USE ONLY

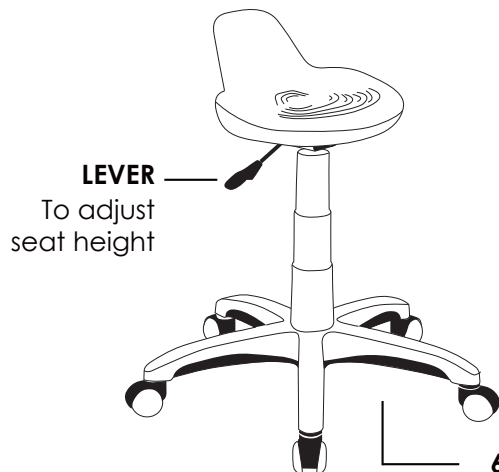

BACK LEVER
To adjust back angle

FRONT LEVER
To adjust seat height

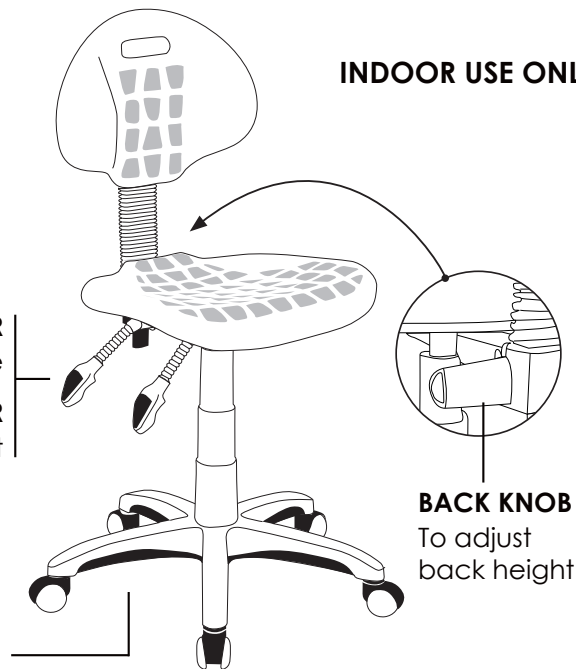

**600MM BLACK NYLON
5 STAR BASE WITH CASTORS**
Keep a permanent contact
between base of chair and floor

X Do not use as a step ladder

DIMENSIONS: (mm)

ST001	SEAT	SEAT TO FLOOR	BACK TO FLOOR
DI: 330	Lowest: 415	Lowest: 550	Highest: 690

ST007	SEAT	SEAT TO FLOOR
W: 460	Lowest: 440	Highest: 580
D: 410		

ST007	BACK	BACK TO FLOOR
W: 405	Lowest: 710	Highest: 990
H: 310		

ST008	SEAT	SEAT TO FLOOR
DI: 340	Lowest: 410	Highest: 550



ST001



ST007



ST008

Features:

Adjustable seat height
Adjustable back height (ST007 only)
Adjustable seat angle (ST007 only)
Optional glides or brake castors

600mm black nylon 5 star base
Available in black only
Suitable for indoor use only
Do not use as a step ladder



Optional drafting kit

CAD RANGE

INSTRUCTION OF USE



CAD

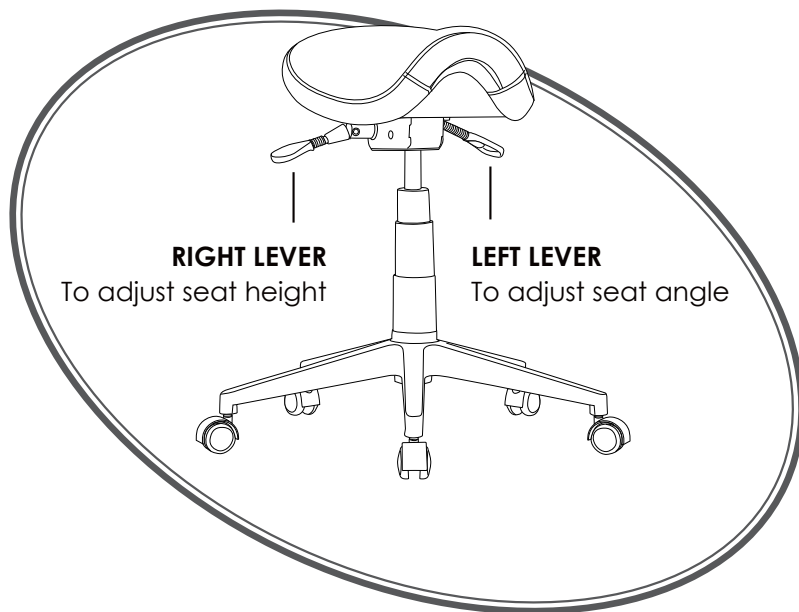

Features:

- Adjustable seat height
- Adjustable seat angle
- Optional glides or brake castors
- Saddle seat

- 640mm black nylon 5 star base
- Available in black PU only
- Do not use as a step ladder



Optional drafting kit

WARRANTY 5 Year	WEIGHT LIMIT 120 Kilogram	IMPORTED 
-------------------------------------	---	--

DIMENSIONS: (mm)

SEAT	SEAT TO FLOOR
W: 390	Lowest: 530
D: 410	Highest: 640

STAGE RANGE



STAGE

INSTRUCTION OF USE

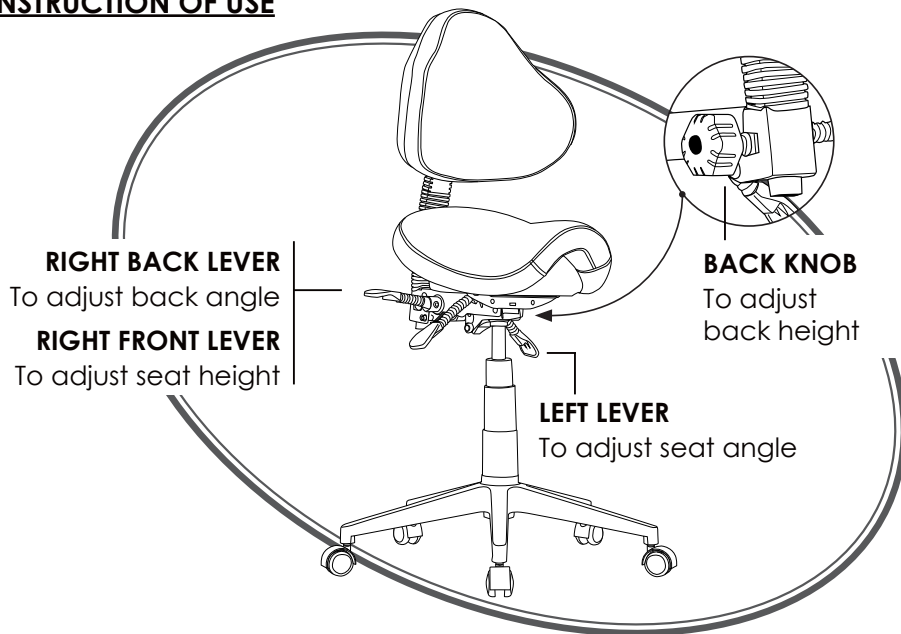

Features:

WARRANTY 5 Year	WEIGHT LIMIT 120 Kilogram	IMPORTED
-------------------------------------	---	---------------------

- Adjustable seat height
- Adjustable back height
- Adjustable seat and back angle
- Optional glides or brake castors

- Saddle seat
- 640mm black nylon 5 star base
- Available in black PU only
- Do not use as a step ladder



Optional drafting kit

DIMENSIONS: (mm)

BACK		BACK TO FLOOR	
W: 430	H: 340	Lowest: 875	Highest: 985
SEAT		SEAT TO FLOOR	
W: 390	D: 410	Lowest: 530	Highest: 640